



Matrix People Mobility Solution

Right People in Right Place at Right Time

EXPECT MORE.

How Unmanageable People's Movement Affect your Organization?



Productivity Reduction due to Inaccurate Attendance Management

- Using Traditional Attendance Management Method
- Error Prone Employee In-Out Time Data
- No Mechanism to Track Break Hours



Security Threats in Key Areas

- Using Traditional RF Card based Access Control
- Very basic Access Control with Limited Features
- Reactive Access Control



Employee Dissatisfaction with Error Prone Salary Calculation

- Manual Attendance and Leave Calculation for Salary Data
- Long Payroll Calculation Time with Errors
- Decentralized Attendance Data



What Solutions we Offer?



Time-Attendance

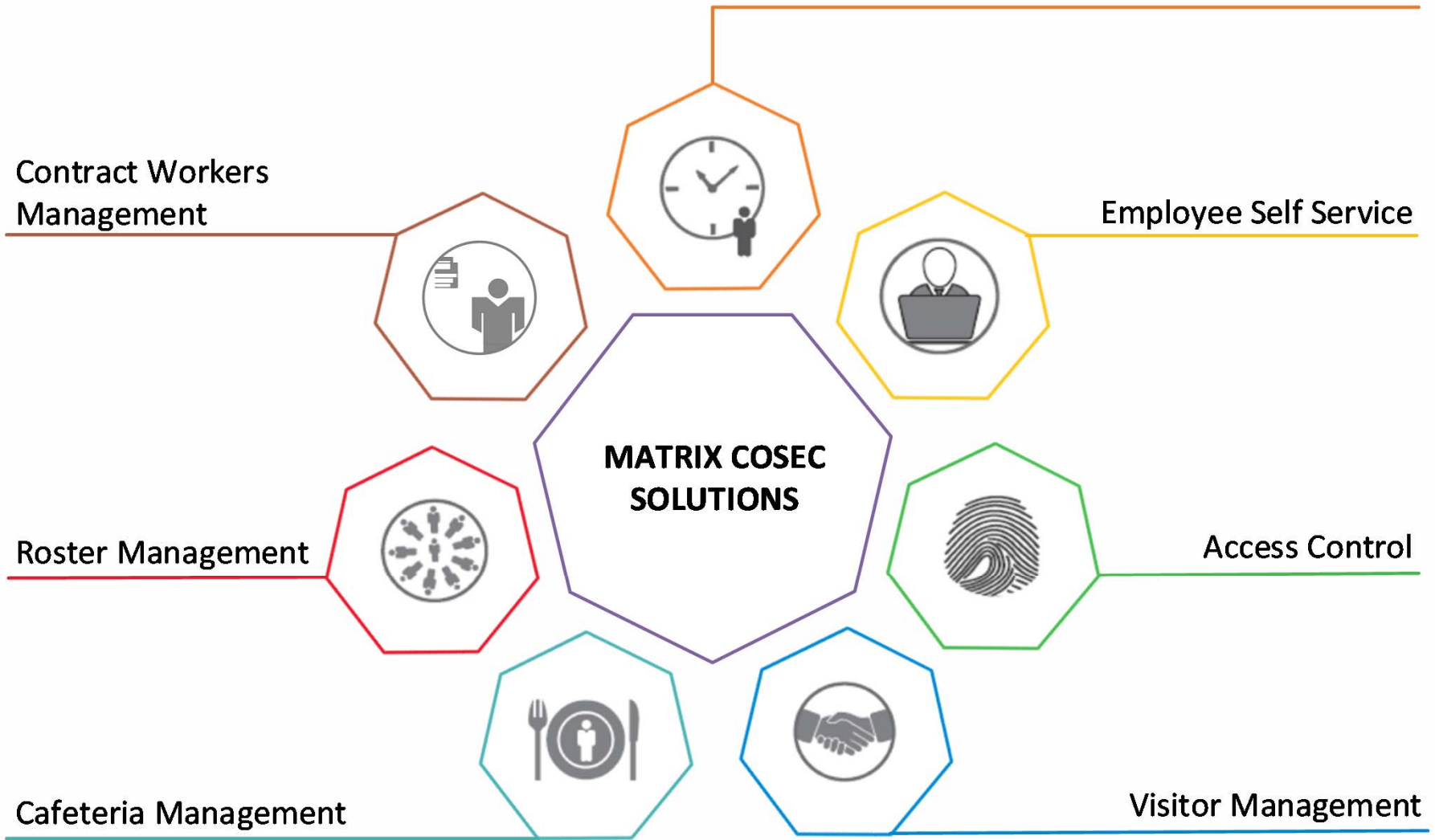

Contract Workers Management

Employee Self Service

Roster Management

Access Control

Cafeteria Management

Visitor Management

What is Matrix COSEC Solution?



A Comprehensive Solution for
Enterprises, SME and SOHO



Multiple Credentials
Palm Vein, Fingerprint and RFID



A Complete Solution with
Hardware and Software

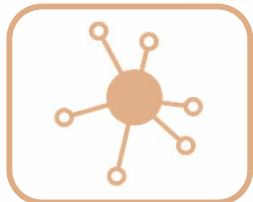

Integrated Solution
3rd Party Hardware and Software Integration



A Solution having
Flexibility, Scalability and Modularity

How We can Help You?



Increase Productivity



Automate Attendance Process



Increase Security



Reduce Payroll Errors



Reduce Cost



Higher Employee Satisfaction

How our Offerings are Different?

Real Time Data Transfer to Server



COSEC Devices
Location 1

COSEC CENTRA Server
Central Location

COSEC Devices
Location X

- Data Transfer from Device to Server in **<1 Sec**
- **Auto Push** Technology
- No Need to Download Manually

Automatic Fingerprint/Palm Template Distribution

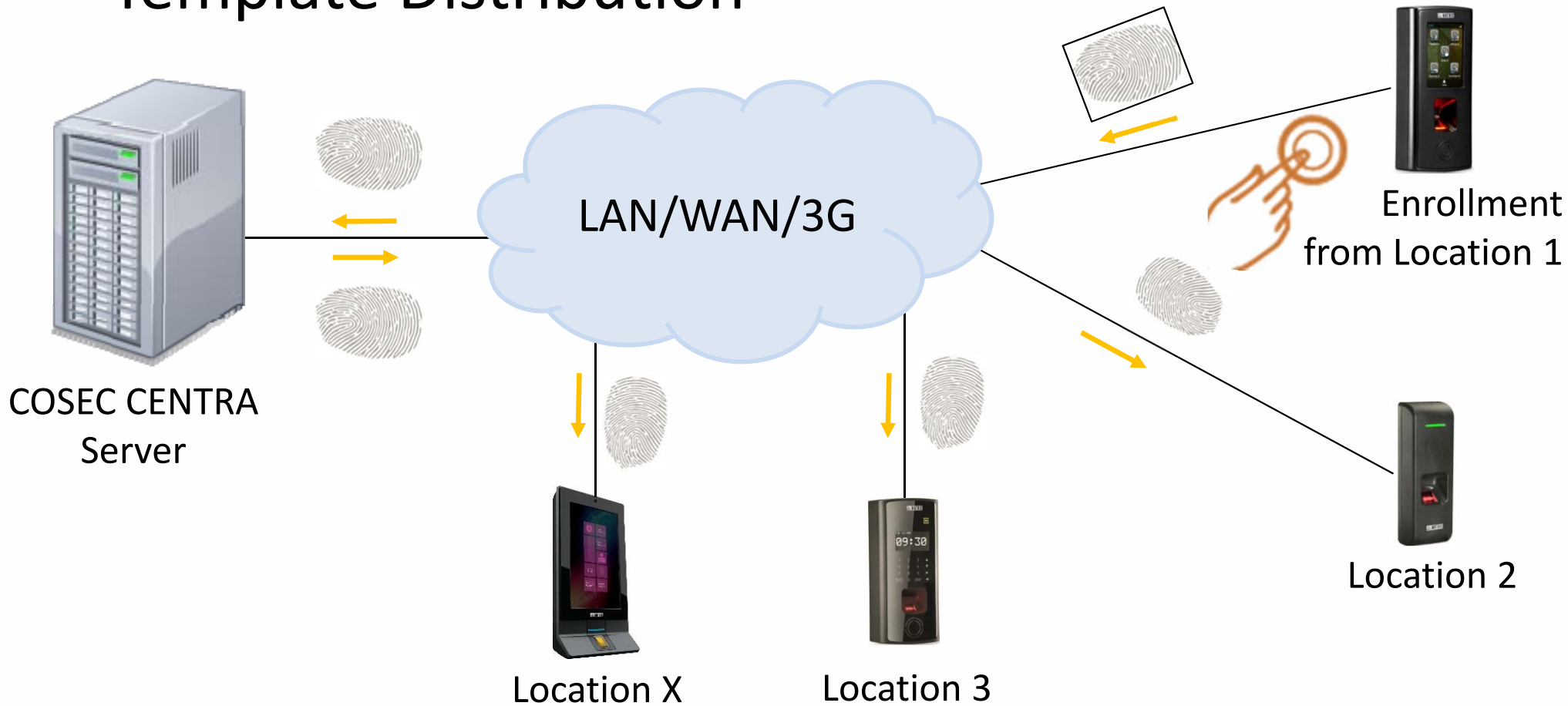

- Distribution from COSEC Server
- No Need to Enroll Again on other Locations

Real Time Notification

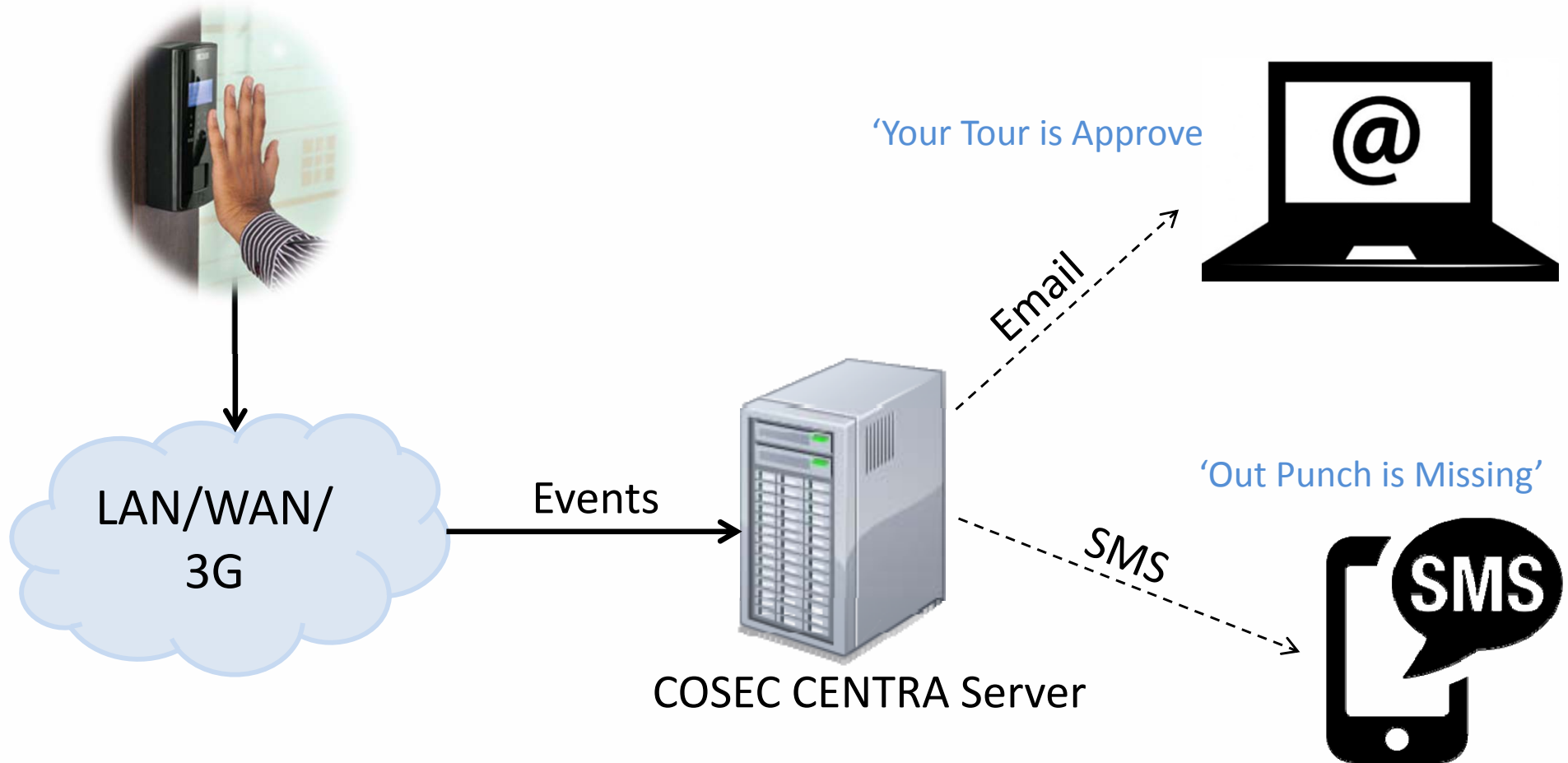

- SMS and Email Notification
- To User or Reporting Officer
- For Attendance, Leave and Access Related Notification

Scheduler Services

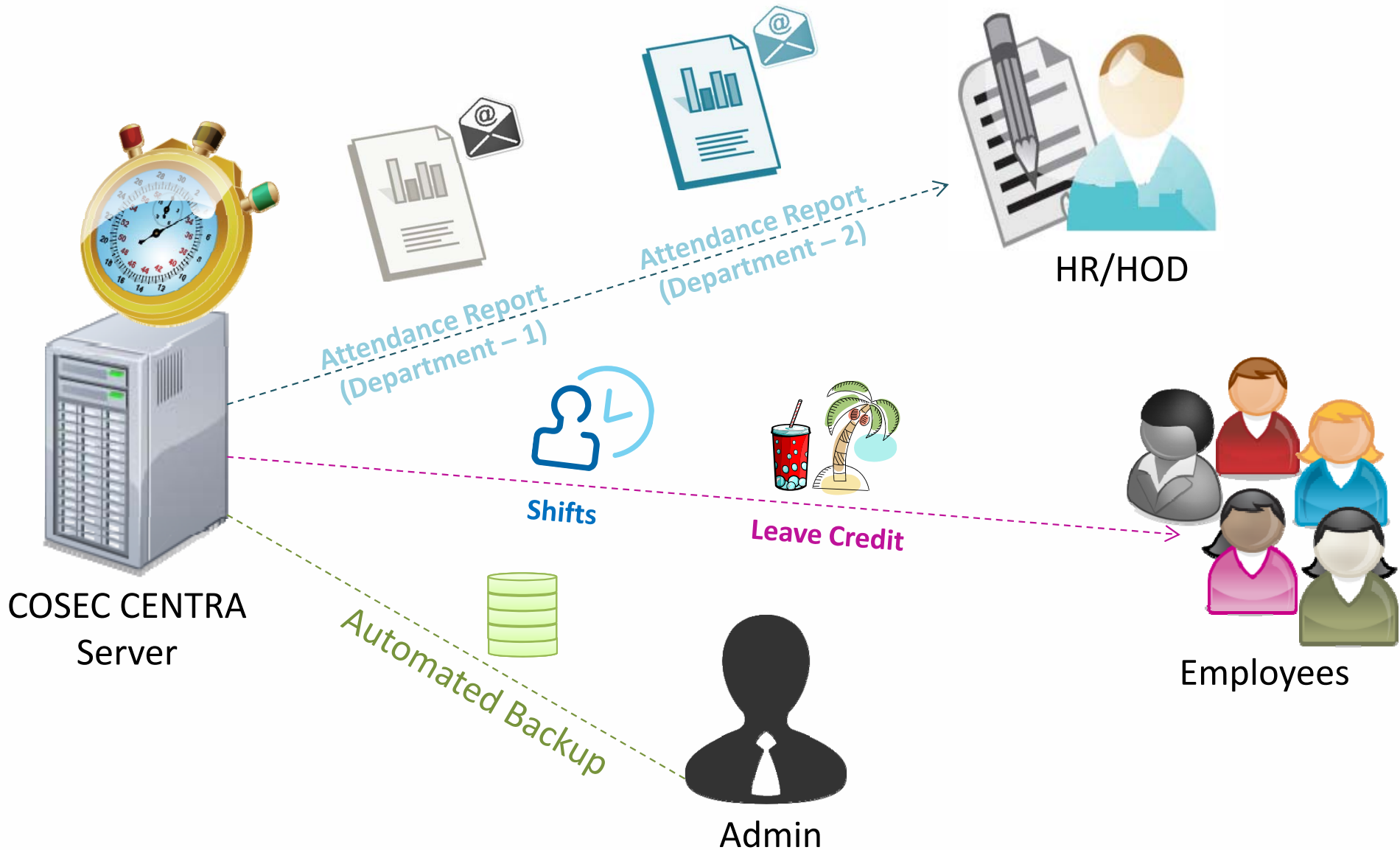

Multiple Connectivity



2G/3G/4G



Wi-Fi



Ethernet/
PoE



USB

Common Power Supply to Drive 3 Devices



IP65 Design



- **Benefits of IP65 Certifications**

- ✓ Resistant to Dust
- ✓ Level of Protection from Liquid
- ✓ Suitable for Weather Proof Installations

- **IP65 Certified Products**

- ✓ COSEC VEGA
- ✓ COSEC PATH



COSEC Architecture

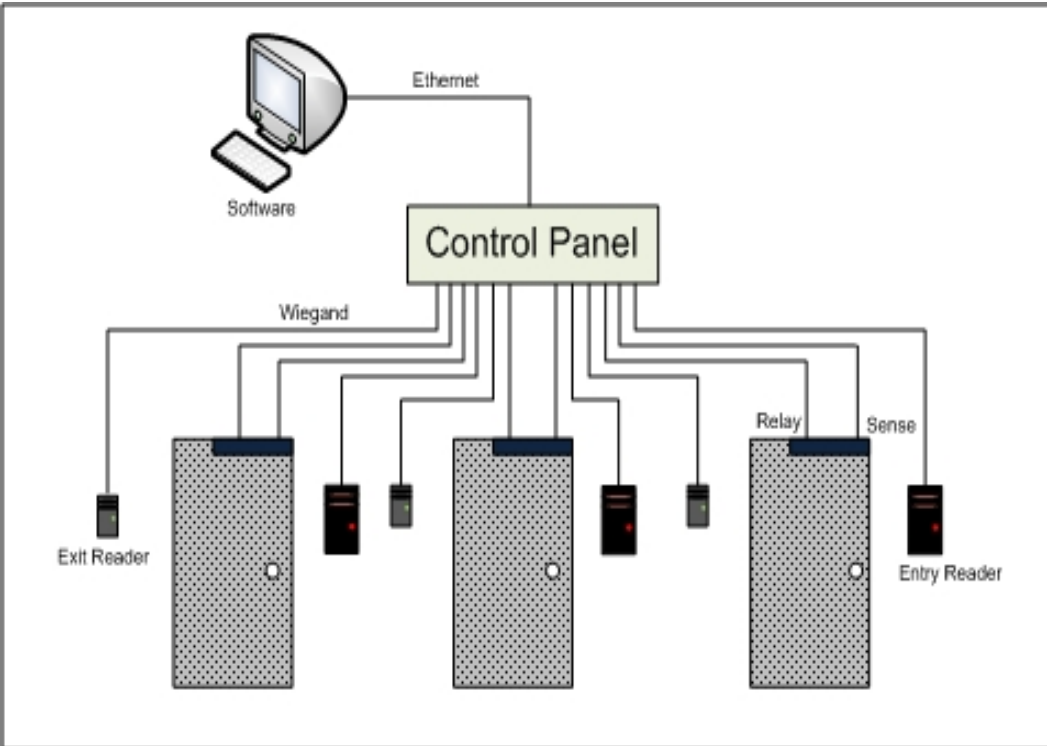

Conventional Systems
Centralized Connectivity

Matrix COSEC
Distributed Connectivity

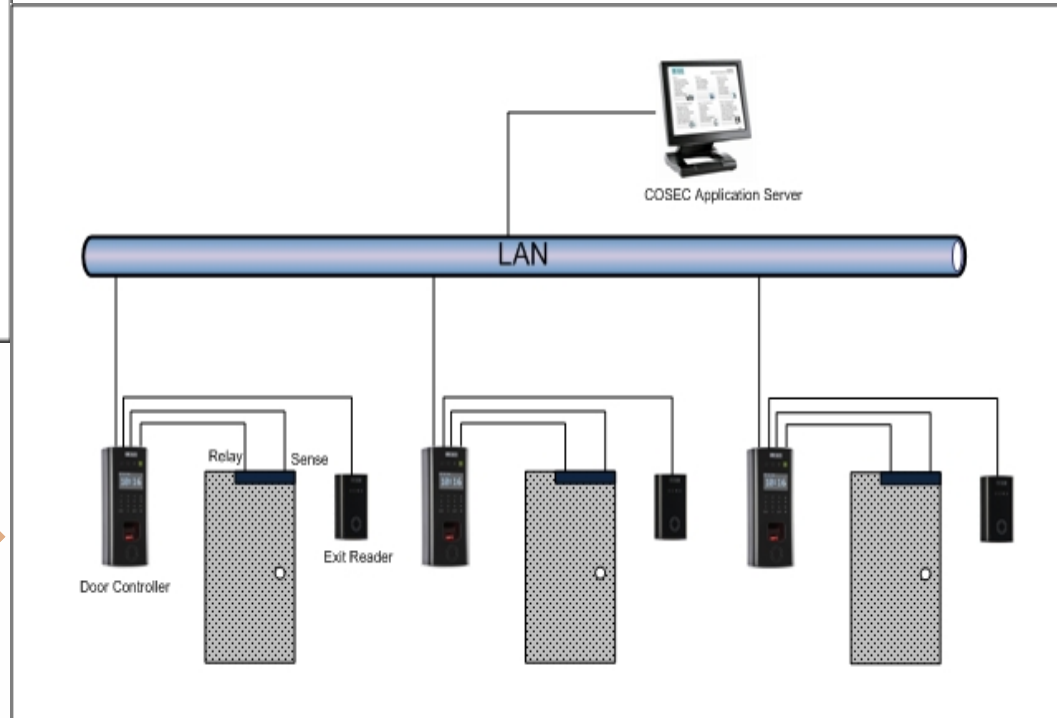

COSEC Architecture Benefits

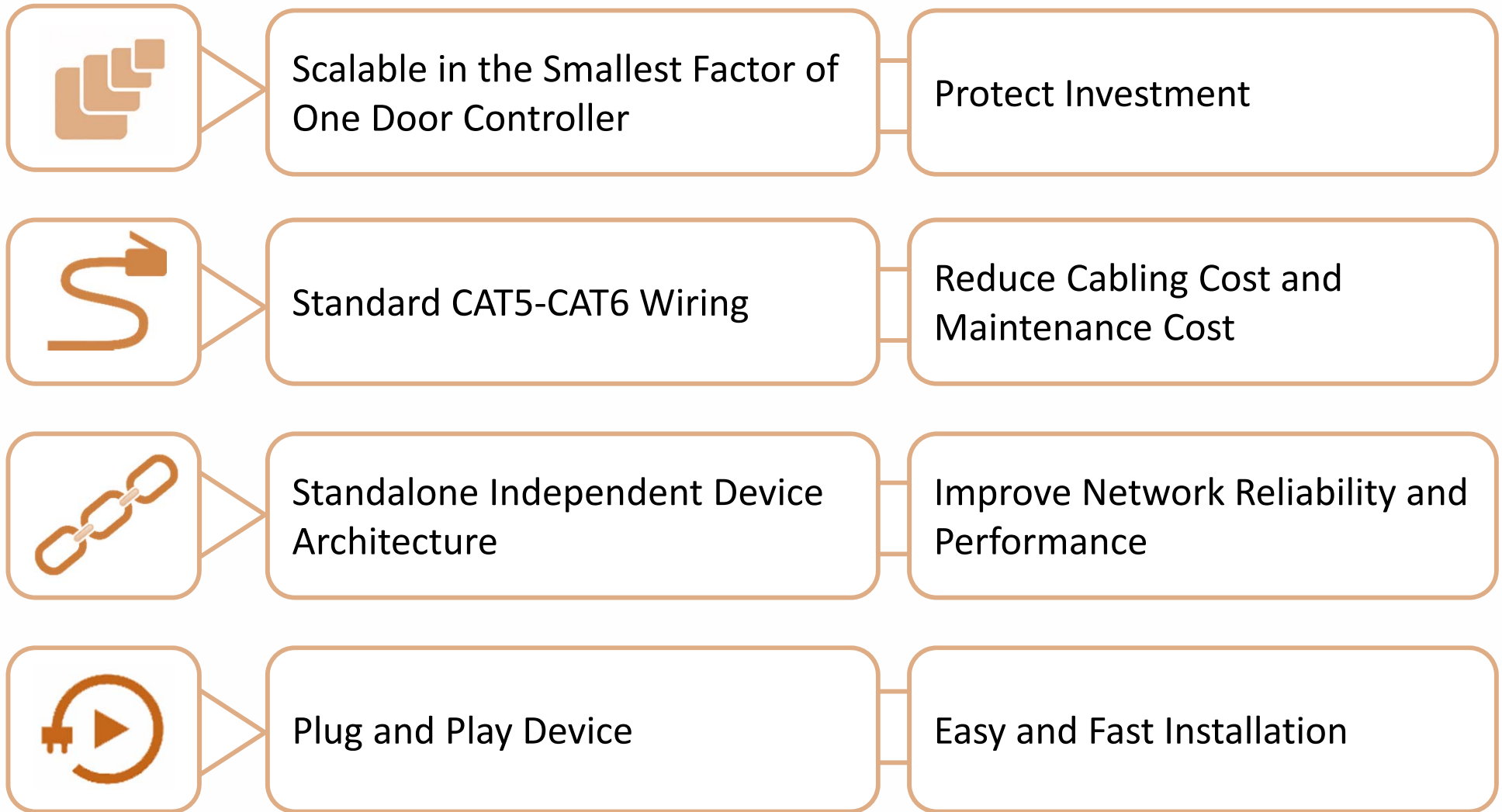

Fingerprint Templates

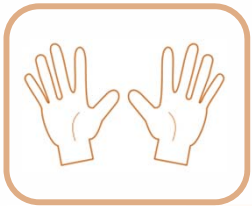

10 Fingerprint Templates per User



9600 Fingerprint Templates



Dual Template to Reduce Rejection

Scalability and Flexibility



65,000 Devices



1 Million Users



Add Software Modules based on Requirements any Time



Web based- Access from Anywhere

Mobile Application

- Mobile Application for Employees and Managers
- Mark Attendance from Mobile
- Track Attendance Using GPS
- View Attendance and Leave Details



Customized Reports and Charts



- 200+ Reports and Charts
- Customized Report Generation
- Apply Filters to Generate Specific Report

Reports in



MS-Excel
MS-Excel Data



PDF



XML



Rich Text
Format



RTP



MS-Word
MS-Word
Editable

Integration with 3rd Party Software

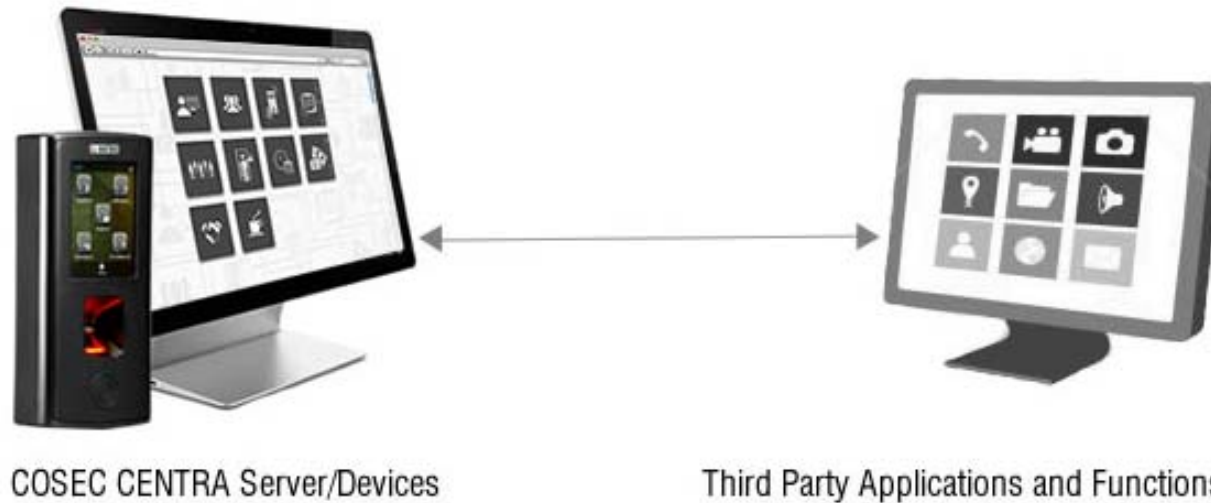

Integration Using

- Database to Database
- API
- Offline Export

Integration with

- Payroll
- ERP
- HRMS
- Active Directory

Our Prestigious Customers



Our Prestigious Customers



BFSI



- Gruh Finance Ltd
- Reserve Bank of India
- Sri Ram Finance
- NBQ Bank (UAE)
- Mahindra Finance
- Vijaya Bank
- Money Matters Securities Pvt Ltd
- MF Global
- State Bank of India
- Surat Peoples Co-Operative Bank
- Islamic Development Bank (Iraq)
- Mahindra & Mahindra Finance

Government



- Power Grid
- Indian Air Force
- Ahemednagar Municipal Corporation
- Bhartiya Rail Bijlee Company Ltd.
- Special Task Force, Kolkata Police
- Bharat Heavy Electricals Ltd (BHEL)
- GNFC
- Ministry of Finance (Indonesia)
- Baroda District Court
- DRDO
- National Library (Vietnam)
- Ministry of Works (Bahrain)

Our Prestigious Customers



Manufacturing



- Adani Enterprises Ltd
- Khimji Ramdas (Oman)
- TATA Steel Ltd
- Tyco Electronics
- Aujan Industries Co (KSA)
- Linde Engineering India Pvt Ltd
- Reliance Industries Ltd.
- Finolex Power Systems Pvt Ltd
- Woodland Limited
- Schneider Electric India Pvt Ltd
- L'oreal India Pvt Ltd
- VIP Industries Ltd

Construction



- Sterling and Wilson Ltd
- Shapoorji Pallonji Co. Ltd
- Raheja Atlantis
- Parshwanath Builders
- Rustomjee
- Reward Constructions Pvt Ltd
- L &T (Kolkata)
- Shubhkamna Buildtech Private Limited
- Al-Khodari Sons Co (KSA)
- Al Majdouie Group (KSA)
- Apex Real Estate (UAE)

Our Prestigious Customers



Pharma & Health Care



- Micro Labs Ltd
- Alkem Laboratories Ltd
- Dr. Reddy's Foundation
- Surien Pharmaceuticals Pvt Ltd
- Rottapharm Co. Ltd. (Thailand)
- Biotech Vision Care
- Fortis Memorial Research Institute
- Gold's Gym
- Viva Gym (South Africa)
- Appllo Hospital
- Riaz Medical Center (Sharjah)
- Al Kamal Pharma & Medical Services (KSA)

IT & Services



- Fedex (Bangladesh)
- Blue Dart Express Ltd
- Real Image Media Technologies (P) Ltd
- TCI
- First Flight Couriers Ltd
- Matrimony
- TATA Consultancy Services Ltd
- You Broadband India Pvt Ltd
- Wipro Ltd
- Collabera Technologies Pvt Ltd
- CMC Limited
- Dozco India (P) Ltd

Our Prestigious Customers



Education



- Euro Kids
- DPS
- Pune University
- MIT, Pune
- Presidency Group of Colleges
- Rishikul Vidyapeeth
- Indian Institute of Science, Karnataka
- Madanapalle Institute of Technology & Science
- British School
- Peterhouse Group of Schools (Zimbabwe)

Other Sectors

- Centrum Printing (Australia)
- Kuwait Oil Company (Kuwait)
- Rabigh Refining & Petrochemical Co. (KSA)
- Khaleej Times (UAE)
- Rotana Jet Aviation (Abu Dhabi)
- McCain Food (India) Pvt Ltd
- Bhutan Fruit Product Pvt Ltd
- Suguna Foods Limited
- Sarovar Hotel and Resorts
- Chennai Silks
- Hotel Fern

Matrix COSEC Solution

Solution Architecture

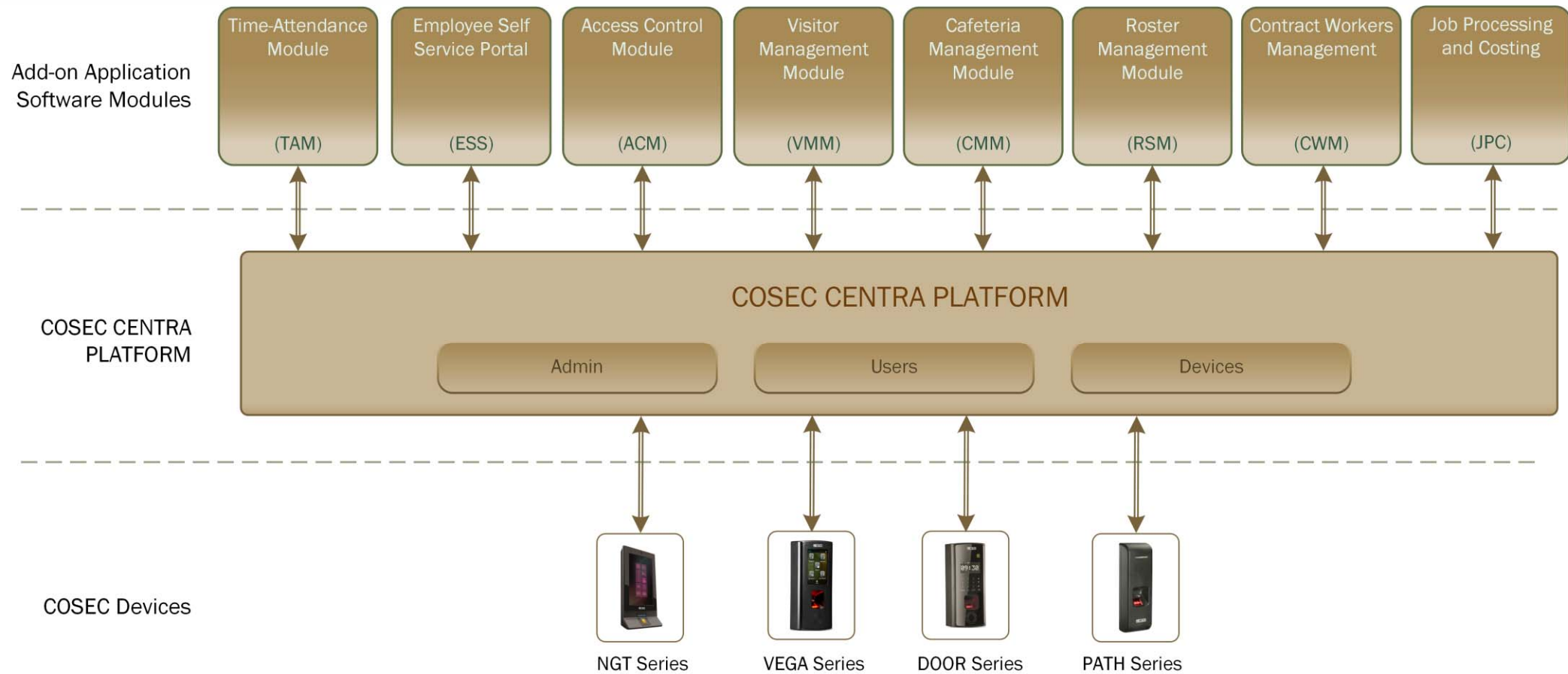

* Please check for availability of "JPC" Add-Ons

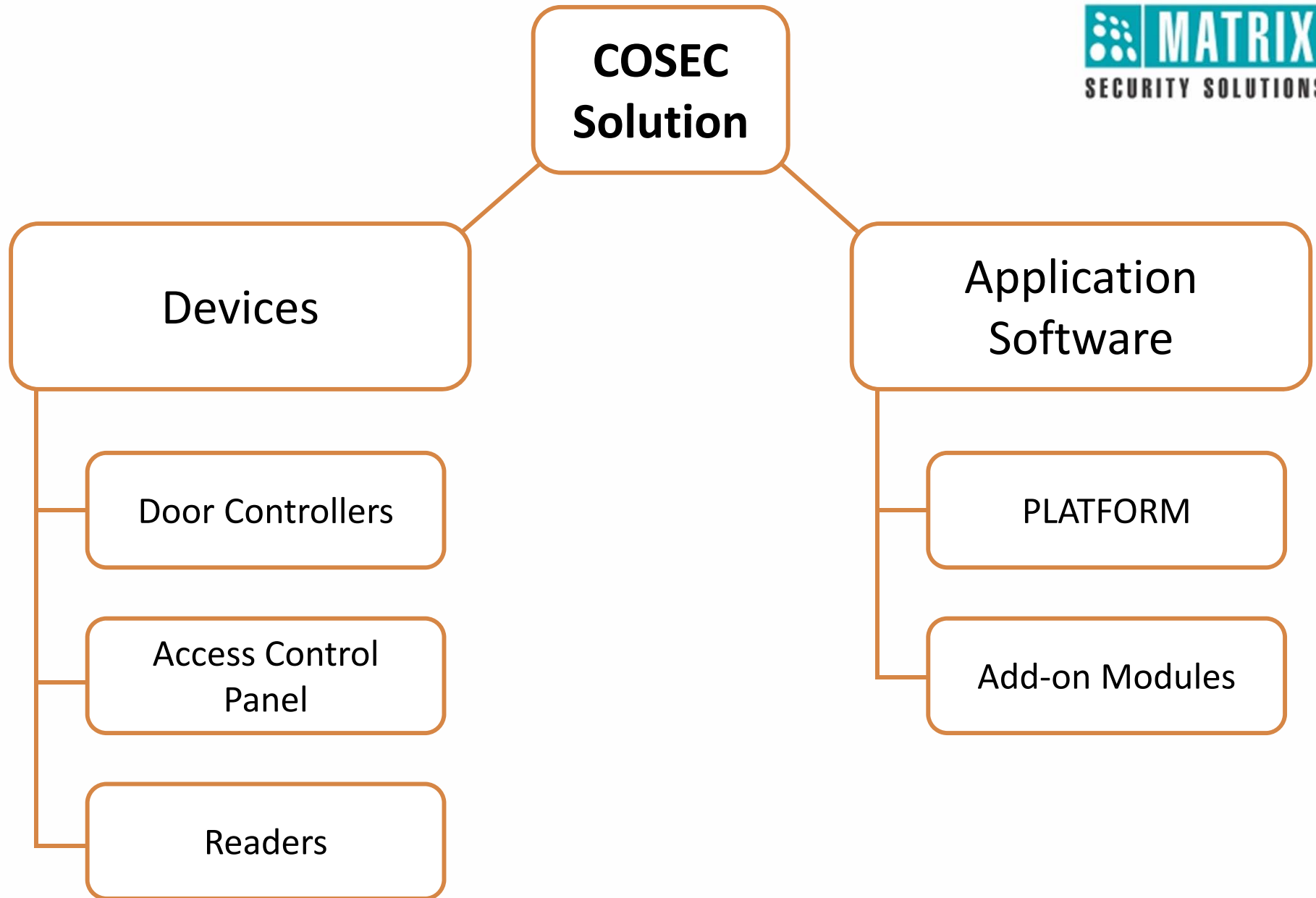

Matrix COSEC Door Controllers

Standalone Door Controller

Time-Attendance and Access Control



DOOR Series

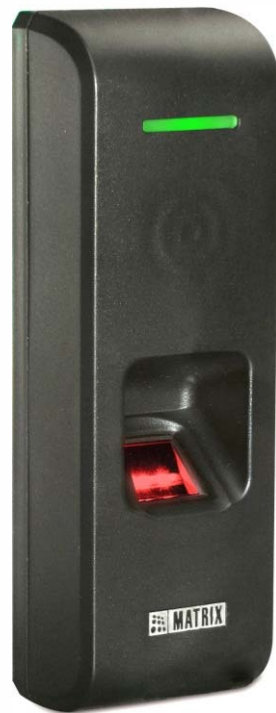

PATH Series



VEGA Series



NGT Series

DOOR Series

With Fingerprint and RFID Card



COSEC DOOR FOP



COSEC DOOR FOT

Access Control and Time-Attendance

Time-Attendance

DOOR Series - Key Features

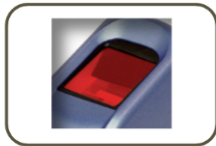

Optical FP
Sensor

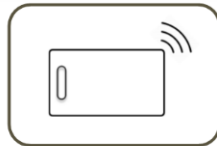

RFID
Card

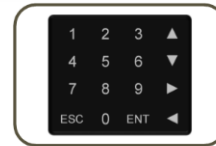

Touch-sense
Keypad



128*64 Dot
Matrix LCD

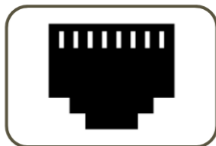

Ethernet Port

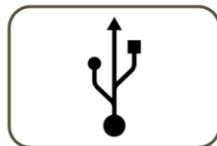

USB Port



Aux-In Port



Aux-Out Port



50,000
Transactions



9600 Fingerprint
Templates



Access Control
Interfaces



LED Indication

DOOR Series

Palm Vein based Door Controller



COSEC DOOR PVR

Access Control and Time-Attendance



DOOR PVR - Key Features



Palm Vein Reader

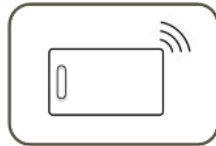

RFID Card



Touch-sense Keypad

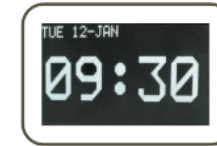

128*64 Dot Matrix LCD

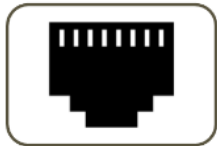

Ethernet Port

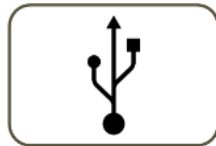

USB Port



Wi-Fi



Access Control Interfaces



50,000 Transactions



20,000 Palm Templates



Aux-In Port



Aux-Out Port

PATH Series

With Fingerprint and RFID Card

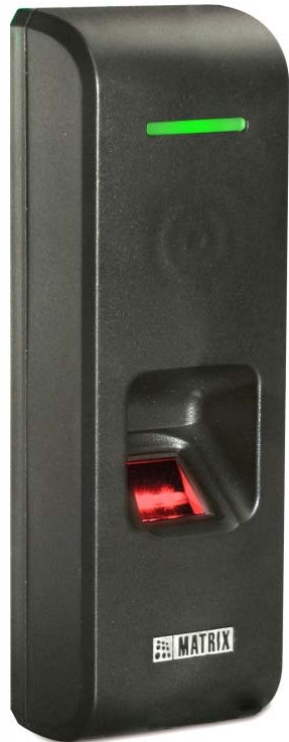

COSEC PATH DCFX
Fingerprint and Card

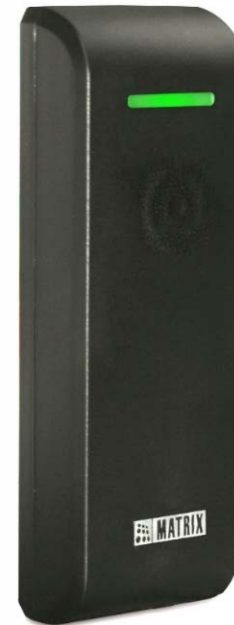

COSEC PATH DCCX
RFID Card

Where X=
E: EM PROX
M: Mifare
I: HID iCLASS
P: HID PROX

Access Control and Time-Attendance

PATH Series - Key Features



Optical FP
Sensor

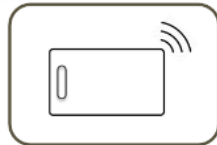

RFID
Card



IP65

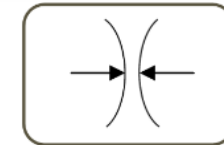

Compact Design

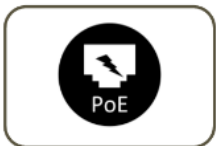

PoE

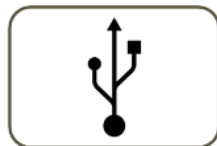

USB Port



Buzzer



Tamper
Detection



50,000
Transactions



9600 Fingerprint
Templates



Access Control
Interfaces



LED Indication

VEGA Series

With Fingerprint and RFID Card



COSEC VEGA FAX
Fingerprint and Card

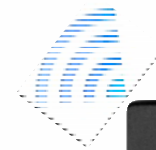

COSEC VEGA CAX
RFID Card

Access Control and Time-Attendance

VEGA Series - Key Features



Optical FP
Sensor

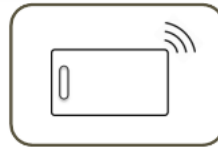

RFID
Card



3.5" Touch
Screen



Multi Media
Features

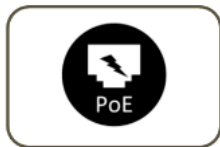

PoE

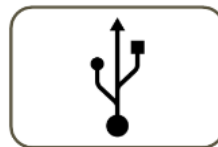

USB Port



Wi-Fi



3G/4G
Connectivity



500,000
Transactions



9600 FP (1:N)
100,000 FP (1:1)



Access Control
Interfaces



IP65

NGT Series

With Fingerprint and RFID Card



reddot design award
winner 2010

COSEC NGT FCX

Access Control and Time-Attendance

NGT Series - Key Features



Capacitive FP
Sensor

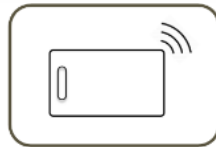

RFID
Card



7" Touch Screen



1.3 MP Camera

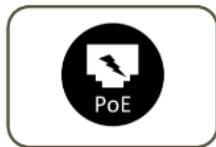

PoE

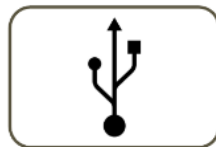

USB Port



Wi-Fi



3G/4G
Connectivity



100,000
Transactions



Multi Media
Features



Access Control
Interfaces



Voice Guidance

COSEC Door Controller Interfaces



Single Door Controller

Access Control and Time-Attendance

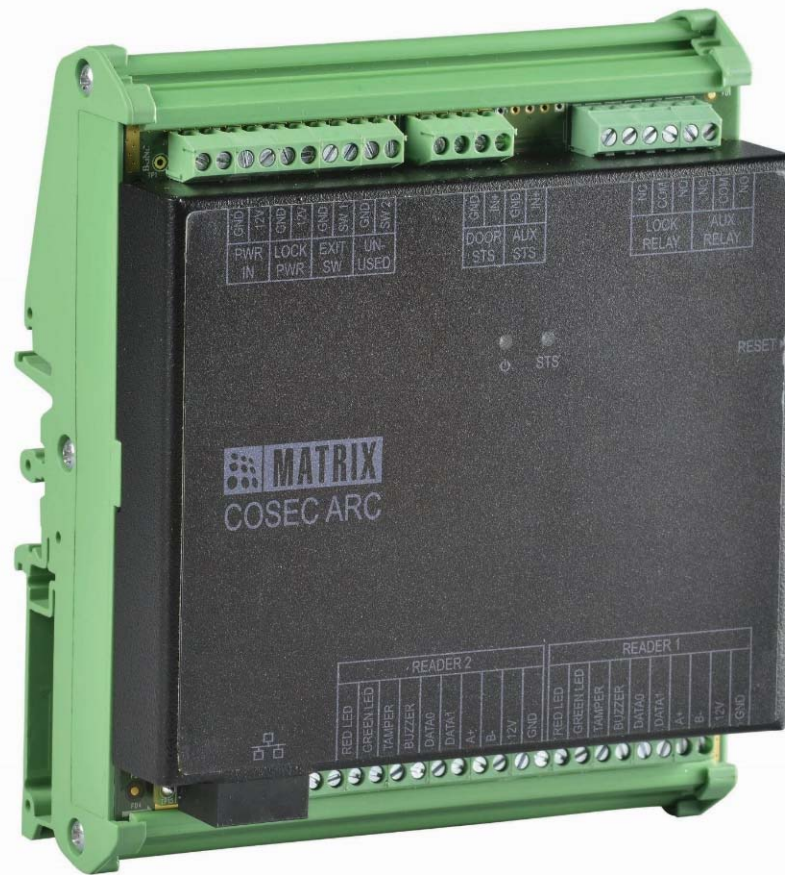

COSEC ARC

Single Door Panel



COSEC ARC DC100P
With PoE



COSEC ARC DC100S
With RS-485

Access Control and Time-Attendance

COSEC ARC - Key Features



- Compact, Single Door IP Panel With PoE
- Operation Modes:
 - ✓ *Standalone Mode* With COSEC PANEL or
 - ✓ *Network Mode* with COSEC CENTRA
- 2-Readers on Wiegand or RS-485
- Support Data and Power on PoE for Readers and Door Lock
- 10,000 Users and 1,00,000 Events Support
- Aux-In and Aux-Out Port
- Din Rail and Box Mounting

COSEC ARC Interfaces

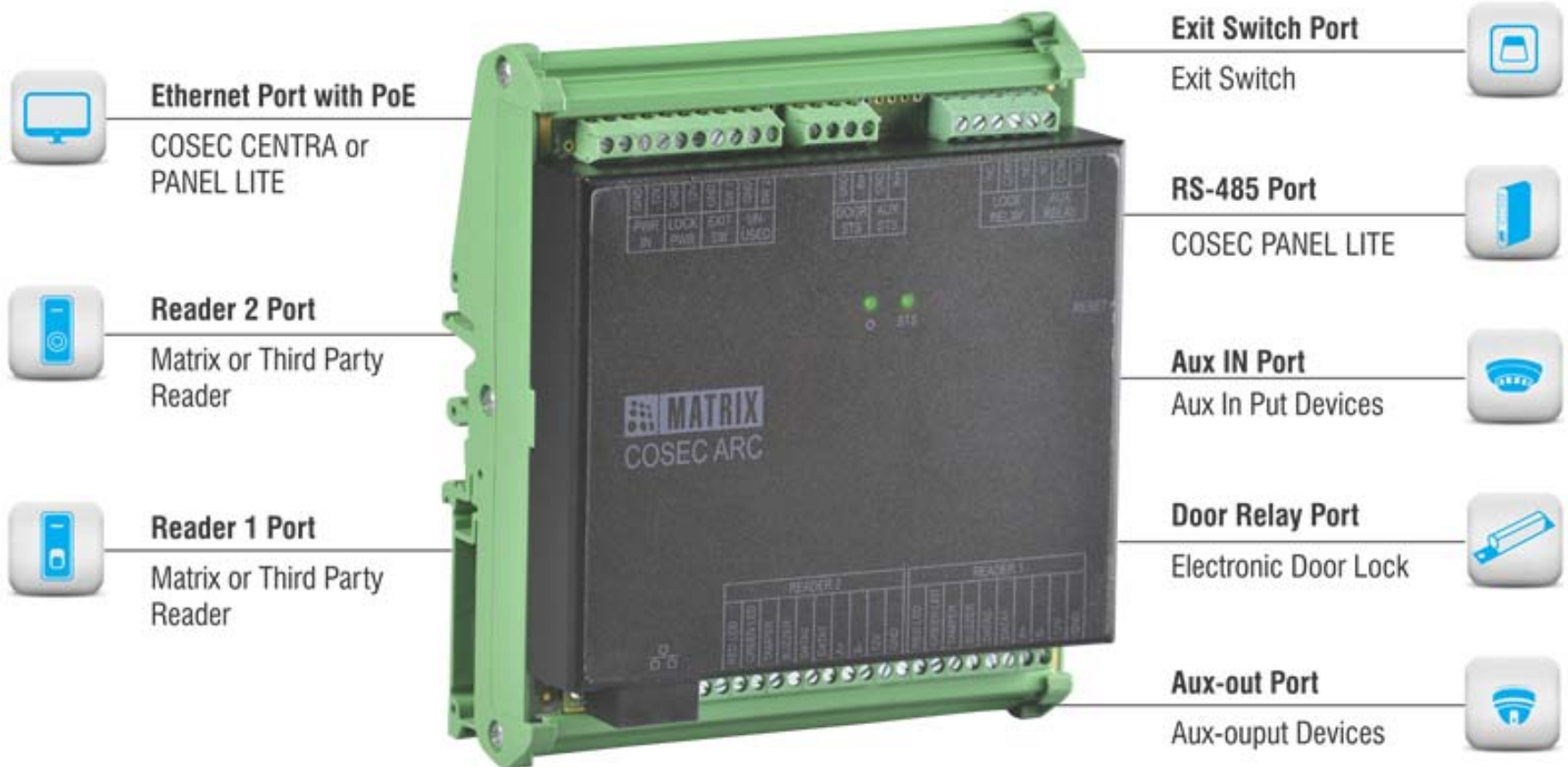

Access Control Panel



Access Control Key Features



- Control 255 COSEC Door Controllers
- Operation Modes:
 - ✓ *Standalone Mode With Built-In Software*
 - ✓ *Network Mode with COSEC CENTRA*
- Ethernet and RS-485 Connectivity
- USB Port for Wireless Connectivity
- 25,000 Users and 5,00,000 Events Support
- Aux-In and Aux-Out Port

Access Control Architecture

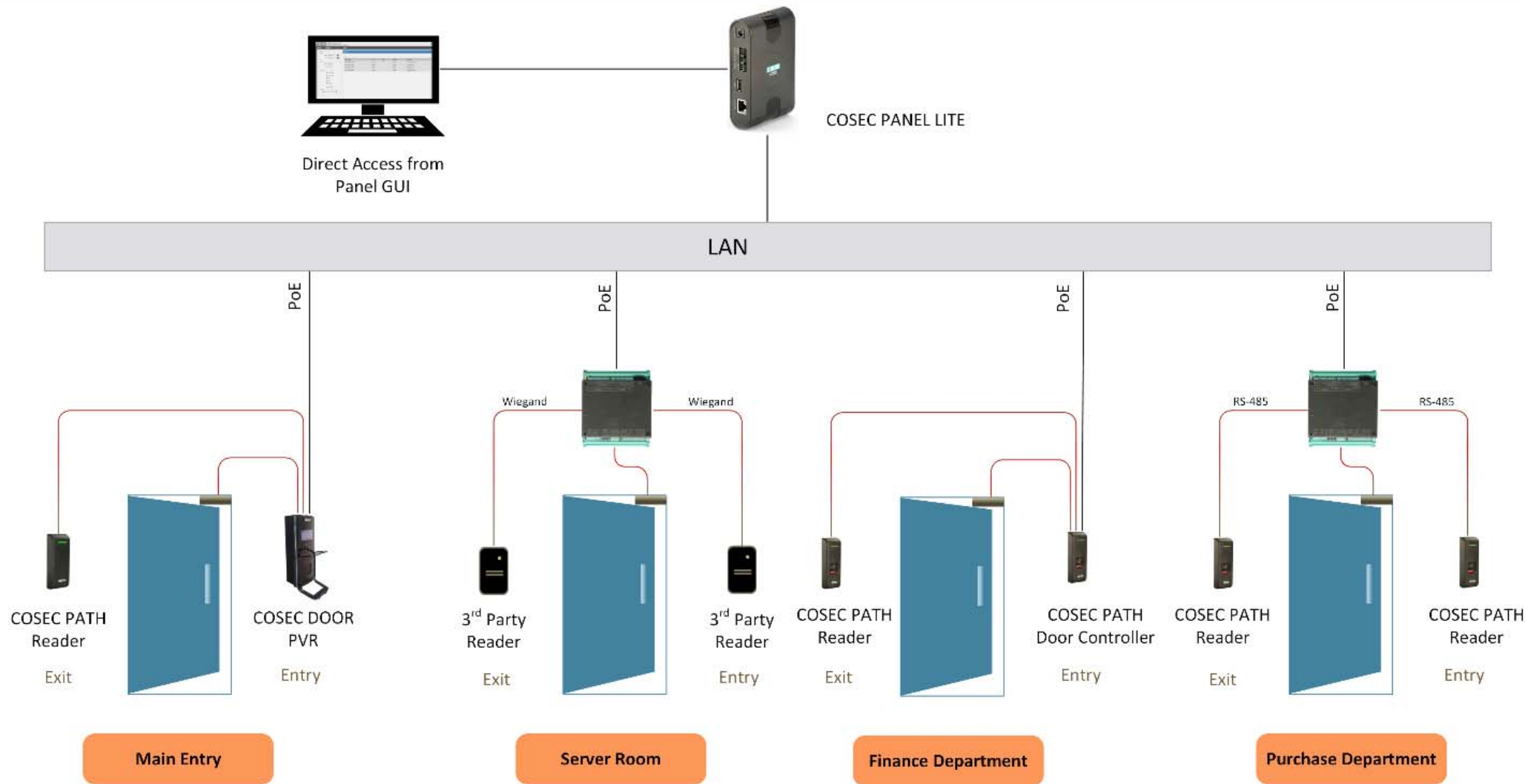

COSEC Access Control Benefits



Scalable

Scalable in the Smallest Factor of One Door
Up to 255 Devices with PANEL LITE

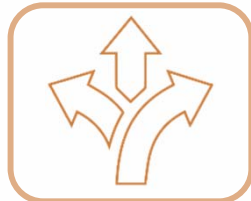

Flexible

Install Near the Door
Reduce Complex Wiring



High Security

Biometric Palm Vein and Fingerprint Reader
Advance Access Control Features



Reliable

Single Independent Door with Distributed Architecture
Standard IP based Wiring



Eliminate Server Cost

Control 255 Devices without Installing any Server
Eliminate Server and Maintenance Cost

Matrix COSEC Readers

PATH Series - Exit Readers

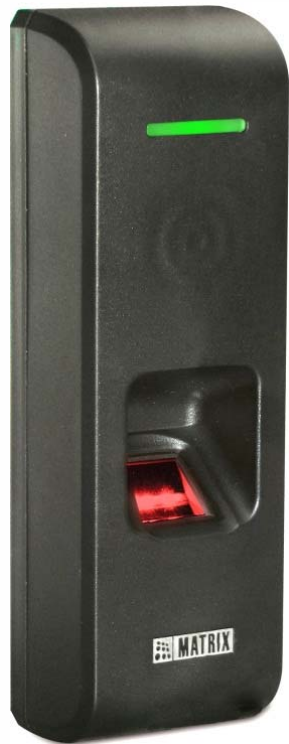

COSEC PATH RDFE
COSEC PATH RDFM
COSEC PATH RDFI
COSEC PATH RDFP
Fingerprint and Card

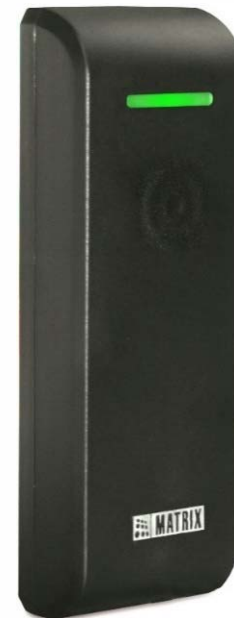

COSEC PATH RDCE
COSEC PATH RDCM
COSEC PATH RDCI
RFID Card

Matrix COSEC PLATFORMs

Application Software PLATFORM



- Web based Application Software
- Controls up to 65,000 Door Controllers and 1 Million Users
- Modular Architecture
- SQL and Oracle Database Support
- Real-time Monitoring and Control

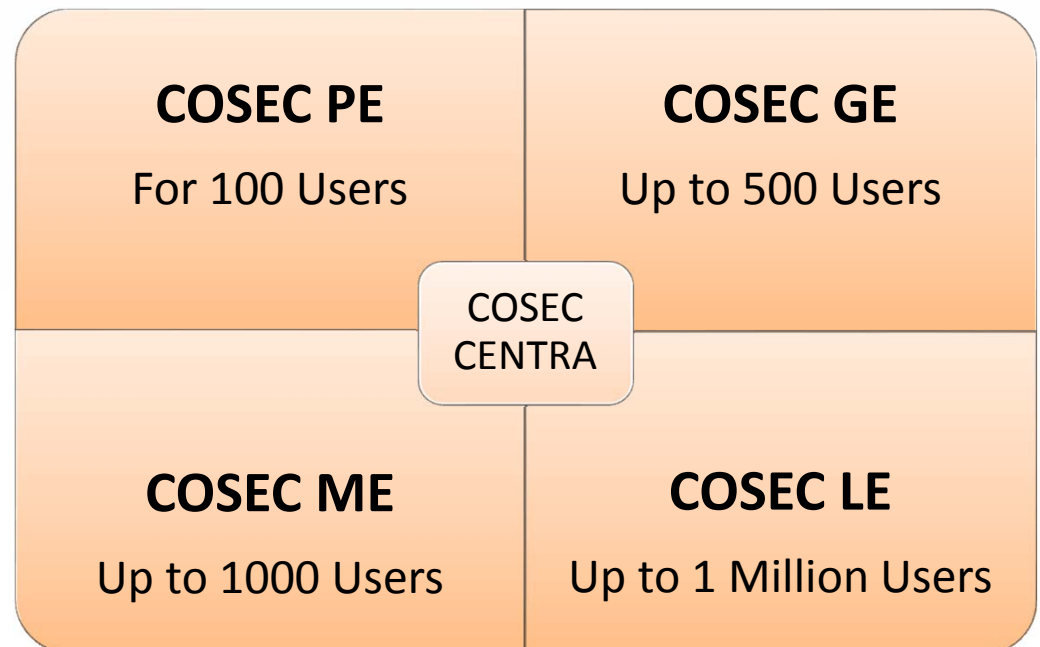

Add-On Software Modules

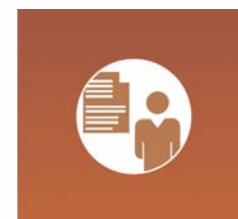
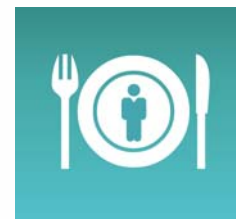

Time-Attendance





Why to Choose Matrix Time-Attendance Solution?

- Pay based on **Actual Working Hours** not Scheduled Time
- **Reduce HR Time** by Avoiding Manual Attendance Management
- Reduce Salary Bills by Calculating **Actual Overtime Hours**
- **Track Employee Movement** and Handle Exception in Real-Time
- Pay **Salary on Time** with Accurate and Fast Attendance Data and Payroll Integration



Matrix Time-Attendance Solution will Fit for your Organizations if You...

- **Manually Enter** Employee Time
- Find **Errors in Attendance** Data
- Need **Centralized Attendance** from Multi Locations
- Track Movement of **Field Employees**
- Manage **Multiple Shifts** and Schedules
- Have Employees with **Different Attendance Policy**
- Using Payroll, ERP, HRMS for **Salary Process**
- Want **Real-Time** Exception Data
- Spend Much **Time in Salary** Processing

Time-Attendance Process

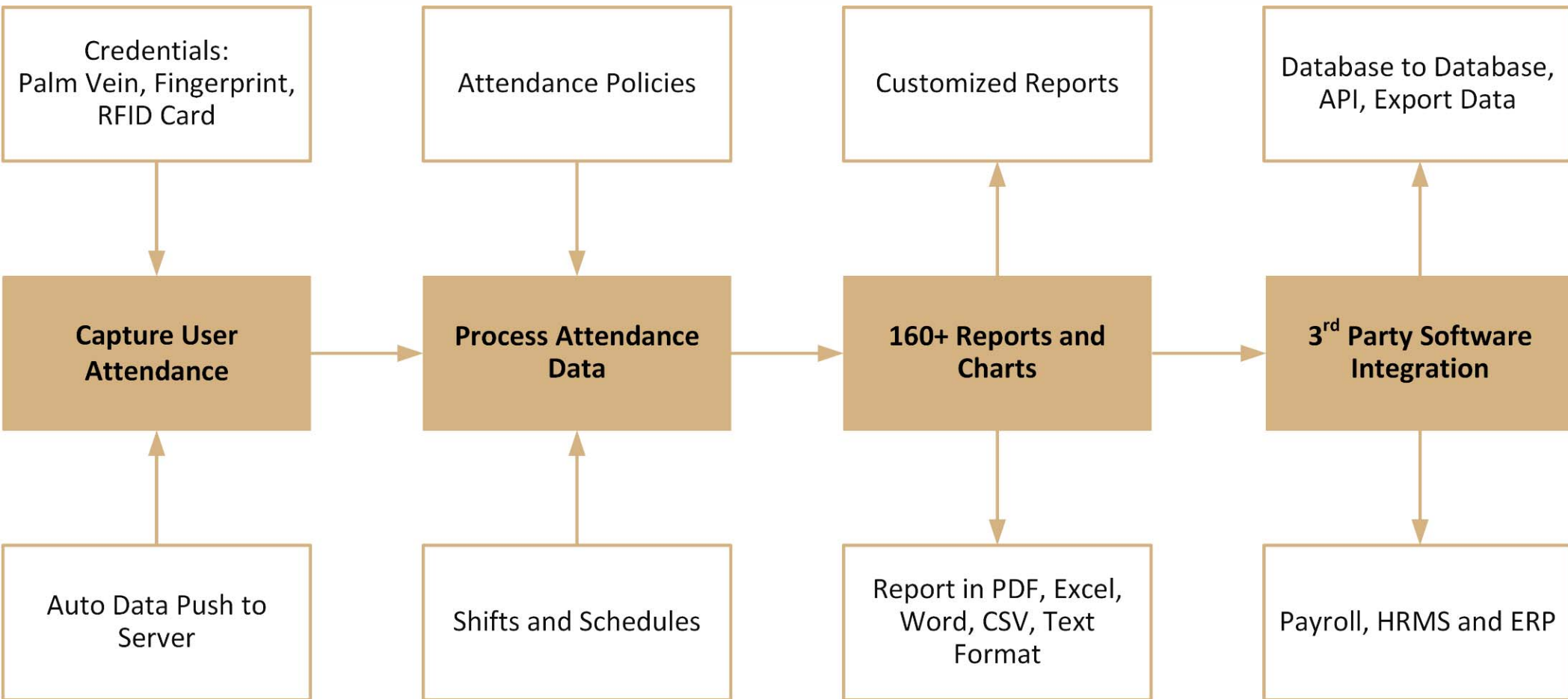

Time-Attendance Solution



Features	Advantages	Benefits
Automated, fool-proof attendance capturing from device	Real time data transfer to server	Eliminate leakages and improve accuracy and employee morale
Selectable entry-exit modes	Accurate monitoring of every entry and exit of every individual	Prevents misuse of policies to improve productivity
Flexible time-attendance policies, shifts, leave policies	Meets disparate needs of different functions, locations, departments	Reduces complexity in work hours calculations
E-mail and SMS notifications	Faster response to exceptional situations	Saves time of HR
Holidays and restricted holidays	30 holiday schedule groups with 32 holidays in each group	Easy to define region wise holidays

Time-Attendance Solution



Features	Advantages	Benefits
Manual entries and corrections of entry-exit events	HR and admin need to spend time only on exceptions	Higher productivity and value-addition
Reports and charts	Ready-availability of accurate attendance data for salary processing	Timely salary payments, reduces errors, improves productivity and employee satisfaction
Integration with 3 rd party application Software	Online and error-free data transfer	Seamless organization for better speed and control

COSEC Time-Attendance Solution for a Single Location

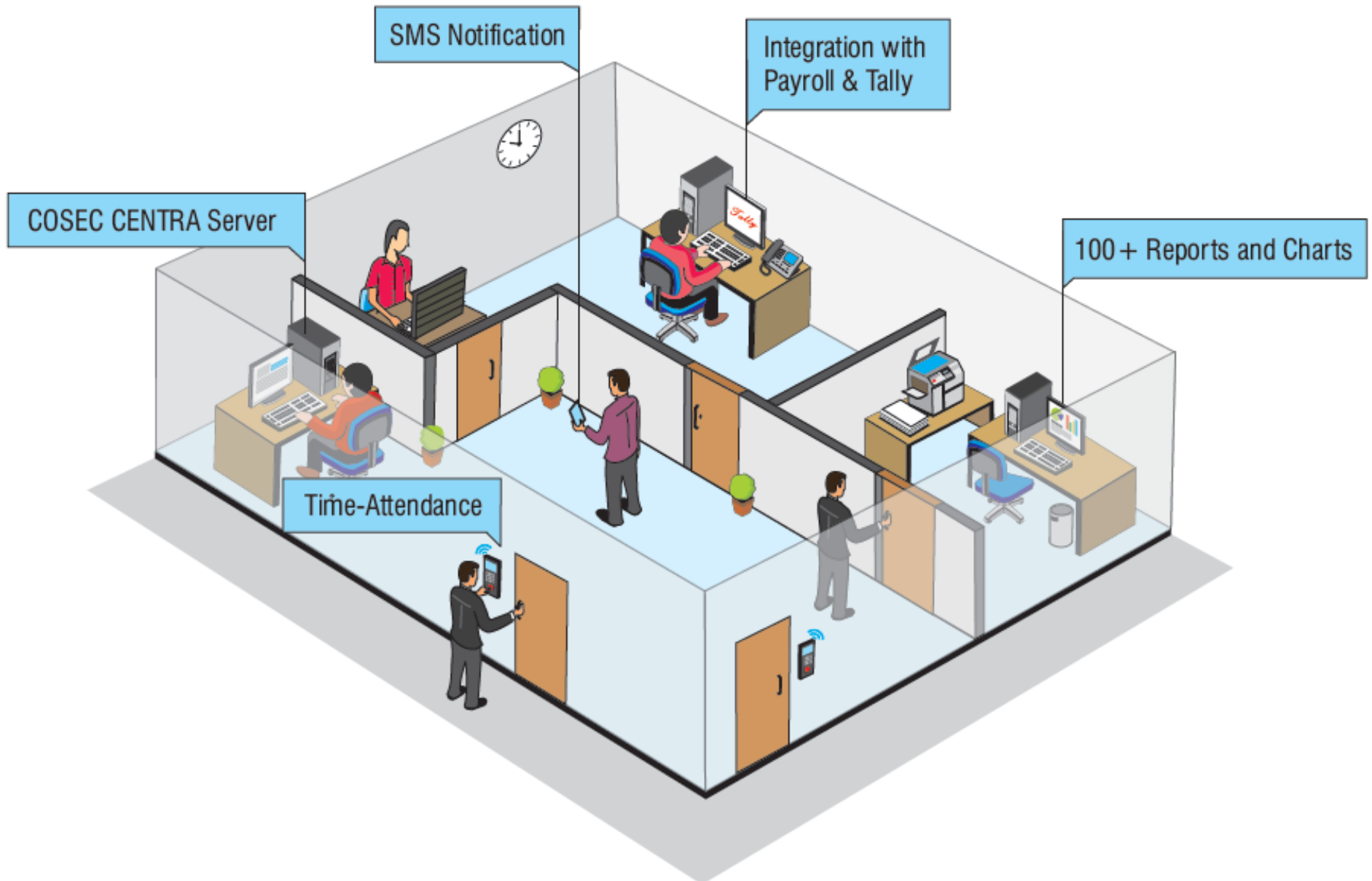

COSEC Time-Attendance Solution for Multi Location Enterprise

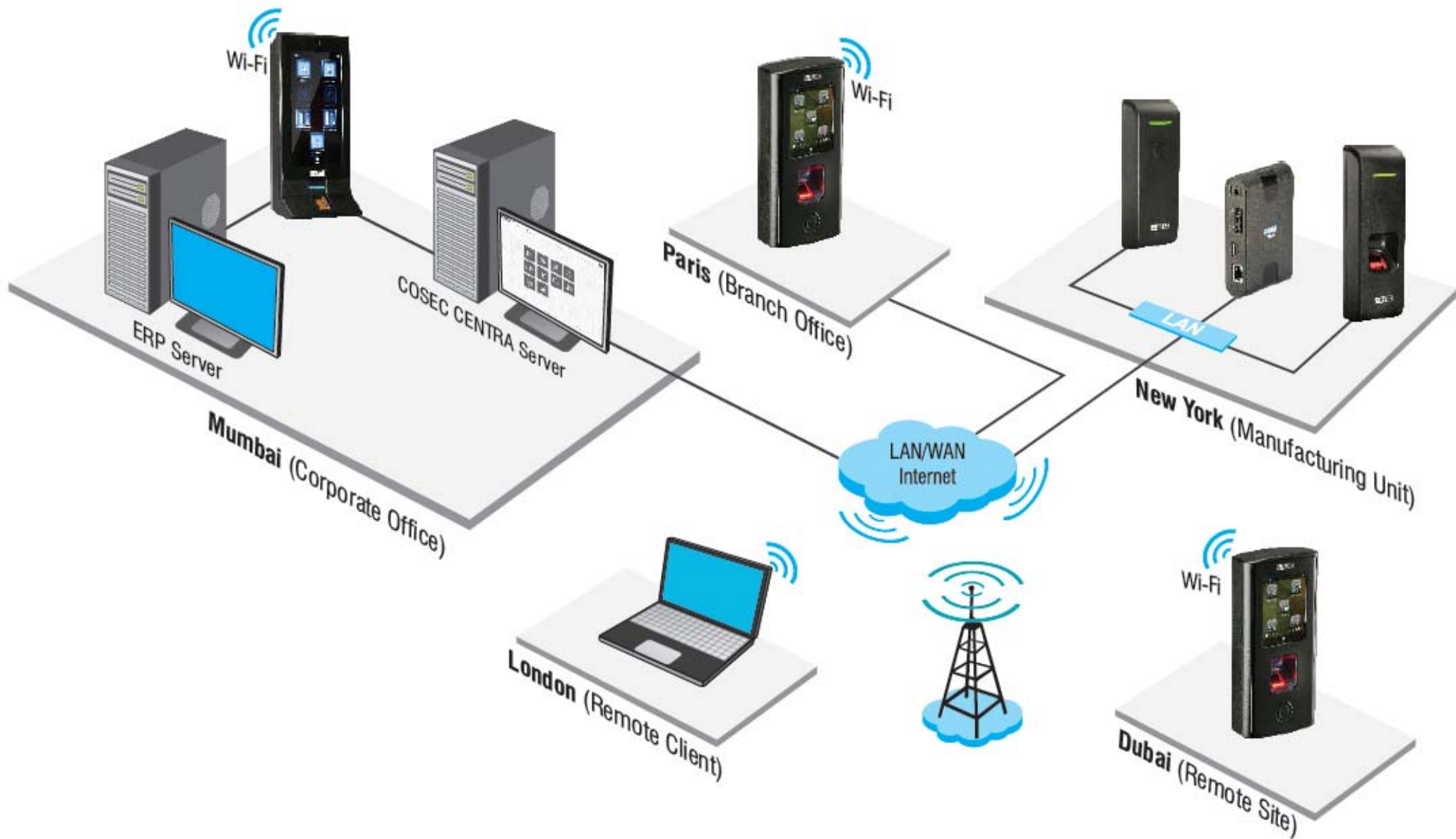

Employee Self Service Portal



Employee Self Service for

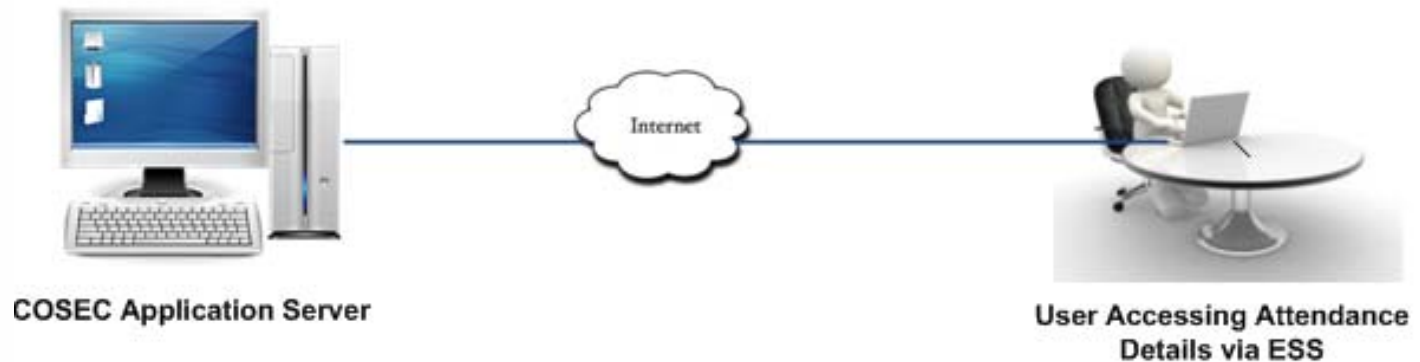

For Employees:

- View Attendance and Leave Details
- Mark Attendance
- View Shifts and Schedules
- Visitor Pre-Registration
- View Cafeteria Details
- Apply for Leave/Tour
- Apply for Attendance Correction
- Edit Personal Information

For Reporting Officers:

- Approve Leave/Tour Request
- Approve Pre-Registration
- Authorized Attendance
- Plan Shifts and Schedules
- View Team Attendance

Employee Self Service Portal



Features	Advantages	Benefits
Informative dashboard	Quick overview of an employee's leave, attendance and shift details	Saves the time and boost productivity
Mark attendance	Mark attendance from anywhere using online portal	Reduces HR 's difficulties in maintain field employee's attendance
View leave, attendance, shift and cafeteria details	Employee can have details as and when required	Improves employee's time management and efficiency
Apply for leave/ tour/ attendance/ cafeteria correction	Eliminate paper work and long processes	Faster Process helps in improve productivity
Add/Edit Personal Details	HR can have error-free and updated database any time	Saves time

Employee Self Service Portal



Features	Advantages	Benefits
Virtual notice board	Update employees with the latest internal and external news and events	Easy to share information/news
Visitor pre-registration by host	Security and reception can use information to prepare a pass	Give a professional impression of the organization
Reporting officer self service	Create and manage shift schedules, approve leaves, authorize attendance and overtime/comp-off hours	Efficient team management

ESS is Available on



COSEC Mobile Application



Features	Advantages	Benefits
GPS based attendance marking	Easy to track field people	Better monitoring and planning
View leave, attendance, shift and cafeteria details	Employee can have details as and when required	Improves employee's time management and efficiency
Approve leave/tour, attendance and cafeteria correction	Manager gets a notification on his mobile whenever any of his members applies	Faster response to exceptional situations
Add/Edit Personal Details	HR can have error-free and updated database any time	Saves time



Access Control



Why to Choose Matrix Access Control Solution?

- Restrict Unauthorized Access in Secured Area
- User Access on Advance Biometric Technology
- Restrict User Access based on User, Zone and Time
- Require Advance Access Control Features
- Centralized Monitoring and Control
- Real-Time Notifications on Exception
- Integrate with Video Surveillance and other Devices

Matrix Access Control Solution will Fit for your Organizations if You...



- Still Rely on **Security Personal** for Organization Security
- Using Traditional **RFID Card** Solution
- Using Access Control with **Basic Features**
- Taking **Actions After the Incident** Happens
- **Managing Devices** from Separate Locations
- Want to **Integrate Other Devices**

Access Control Process

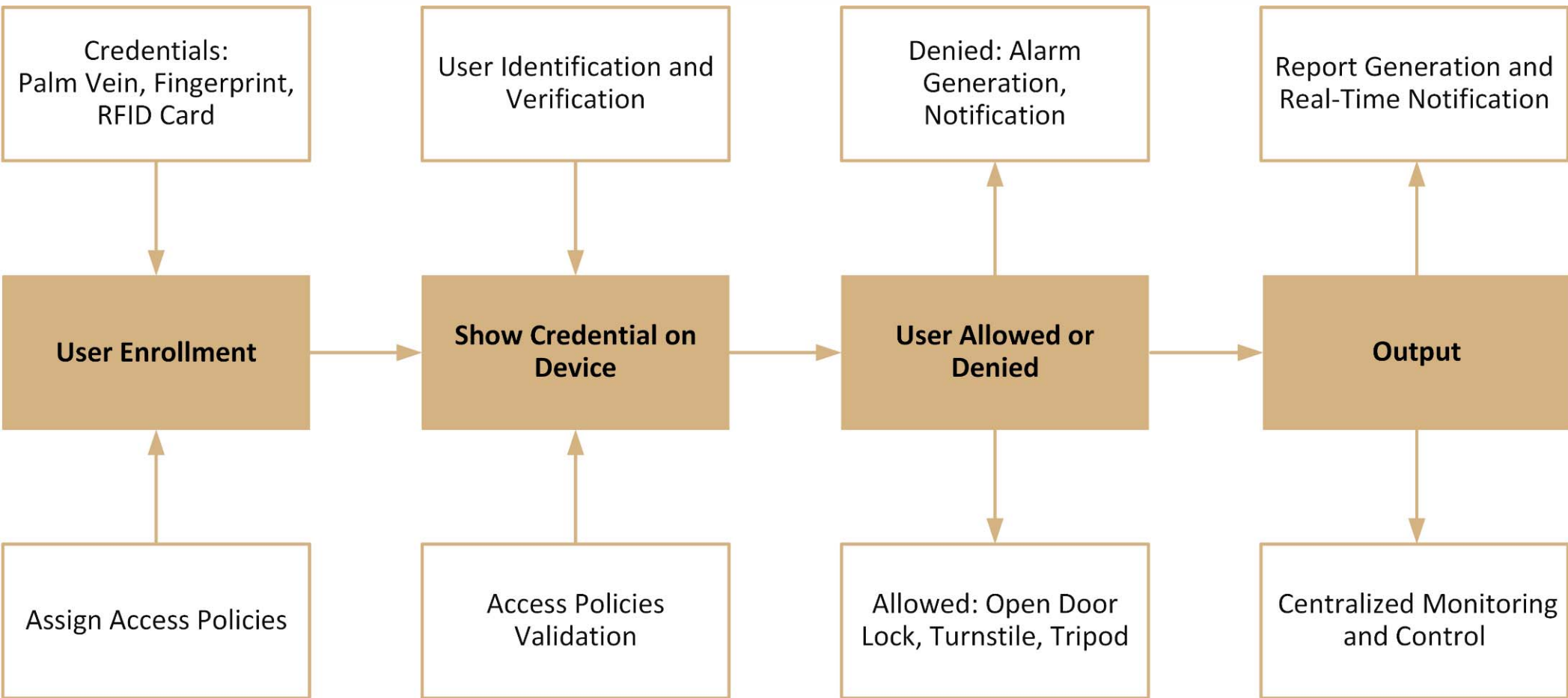

Access Control Solution



Features	Advantages	Benefits
User, time and zone based access control	Control access by deciding who, where and when	Facilitate limited access
Create access zones by dividing organizations into departments	Employee of one department can be restricted from entering into another department	Stop employee roaming and leakages of information from department to department
Guard Tour	Facilitates enforcing vigil patrol of security guards	Immediate action can be taken on notification or alarm for any deviation
2-Person Rule	Allows entry when two persons from an authorized group jointly use their access rights within a specified time	Higher security to sensitive areas like locker, server room, r&d labs, etc.

Access Control Solution



Features	Advantages	Benefits
First-In User	Give access to users after designated person enters	Ensure higher level of safety and security
Smart Card based Identification	User's fingerprint and other information are stored on the smart card instead of the device	Facilitate large number of users more than capacity of device
Anti-Pass back	Second entry using the same card is allowed only after an exit is registered for every entry	Prevents a card holder from passing his card back to another person to gain unauthorized entry
Man Trap	Two or more doors are arranged in a sequence which regulates traffic or control dust and heat	Prevents any intruder from entering or escaping in a hurry

Access Control Solution



Features	Advantages	Benefits
Centralized Monitoring and Control	Shows the current status of all the site controllers, door-controllers, alarms, In/Out ports	Live monitoring and control to check the system in real-time
Configurable Input and Output Ports and Linking	Integration of other hardware for further applications	Higher safety and security
Occupancy Control	Allows only defined number of people in zone	To limit the no. of people in areas like seminar halls, conference rooms and cafeterias
Route based Access	Ensures user reach to location in a particular sequence which is defined on his smart card	Prevents users to wander into premises intentionally or unknowingly

Visitor Management



Visitor Management Process

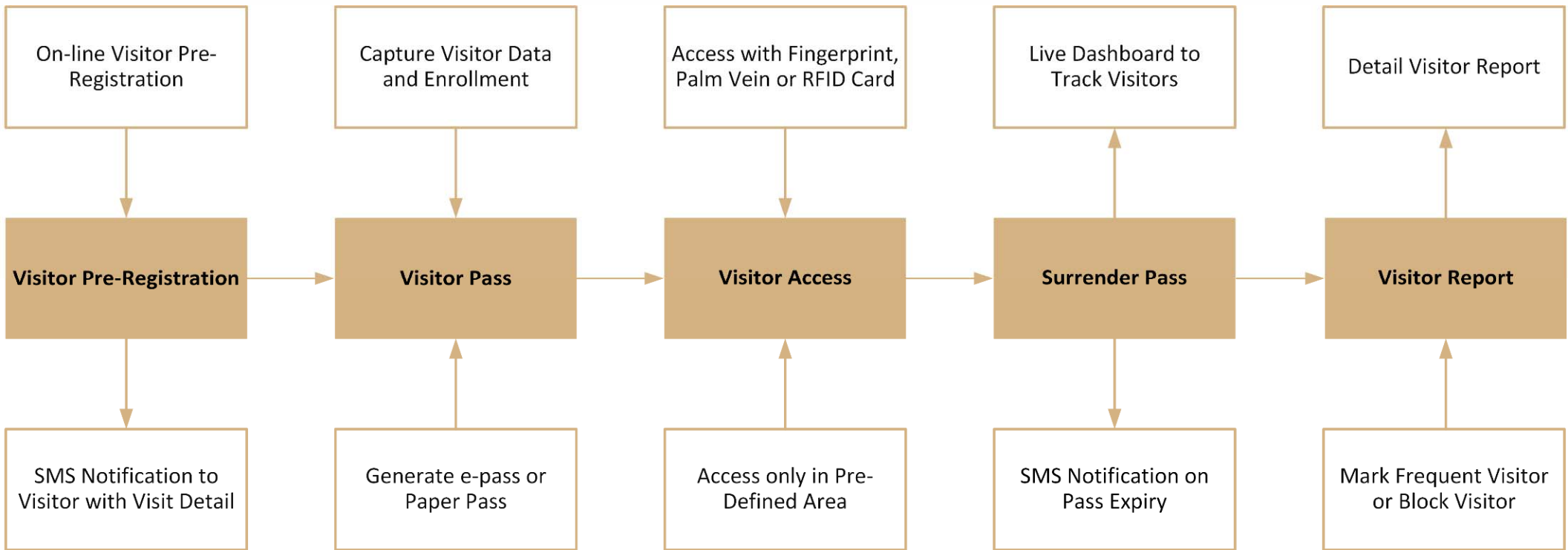

Visitor Management Solution



Features	Advantages	Benefits
Visitor pre-registration	Faster check-in process of visitors	Saves precious time of everyone
Visitor database	Retrieve frequent visitors' details	Incident tracking, analysis and decision making
Visitor access rights	Enroll visitor's fingerprint or RF card to permit access to selected areas only	Protection of valuable assets
Customized visitor pass	Create either an e-pass with access rights or a paper pass	Creates professional image of an organization
Send an SMS or email notification to the visitor and host	Quick check-in process when he arrives at the security gate	Saves time and boost productivity

Visitor Management Solution



Features	Advantages	Benefits
Manage visitor using online portal	Paper-less visitor management	Reduces cost and improves productivity
Frequent visitors	Pull up visitor information from the past records which eliminates the need for data re-entry	Boosts security person's productivity
Visitor dashboard	Quick overview of all the visitors in a graphical format	Faster access of visitor information
Visitor reports	Reports in various file formats	For analysis and decision making

Cafeteria Management

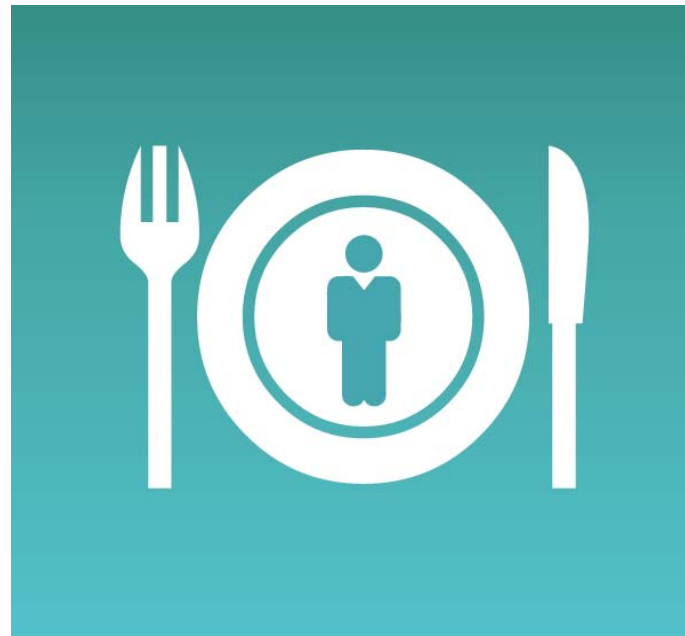

Cafeteria Management Process

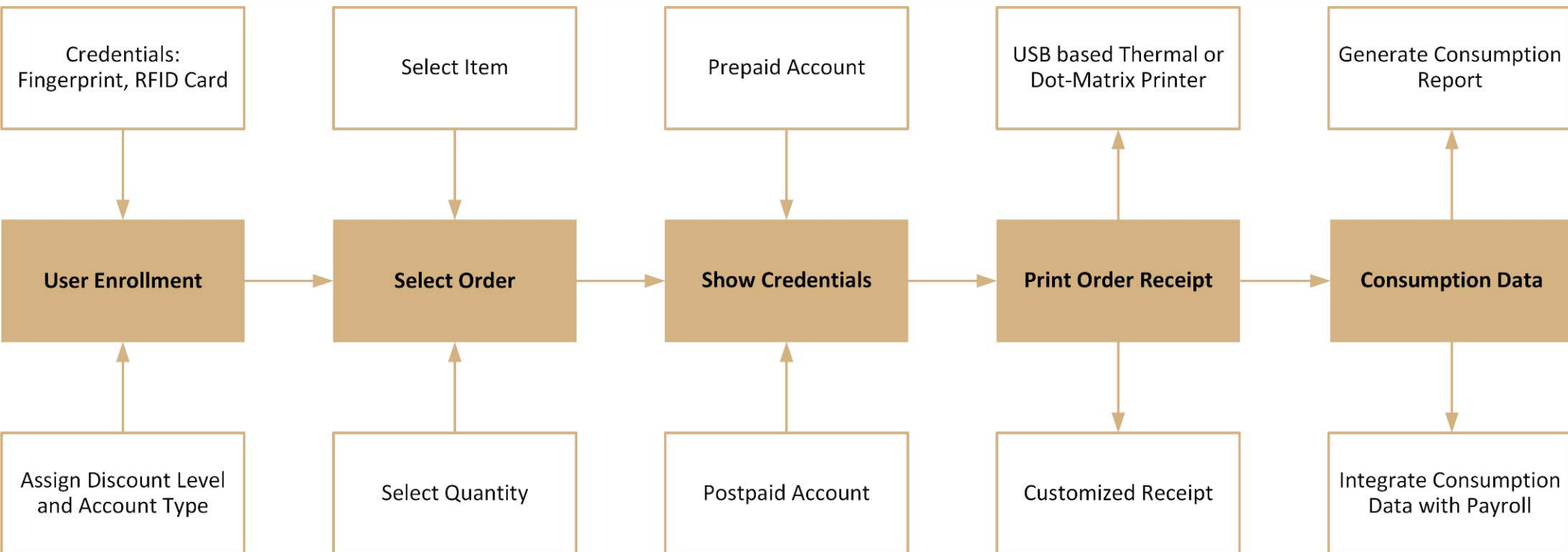

Cafeteria Management Solution



Features	Advantages	Benefits
Create items and menu	Create up to 255 items and 9 different menus	Efficient cafeteria management
Menu schedule	Schedule and display different menus for specific dates, days and time	Easy to order from menu on display
Prepaid and postpaid user accounts	Cashless transactions	Accuracy and speed
Blocked users when consumption has exceeded their pre-fixed limits	Auto watch on users	Accurate calculation of consumption
Printer connectivity to generate food bill	Receipt for each user with transaction detail like items, rate and quantity	Faster bill payment

Cafeteria Management Solution



Features	Advantages	Benefits
Export data to 3 rd party payroll and billing software	Avoids need for manual data entry or data transfer	Saves time and eliminate possibility of human errors and manipulation
Informative Reports	Item tracking to prevent wastage of food	Better food planning

Contract Workers Management



Contract Workers Management (CWM) Process

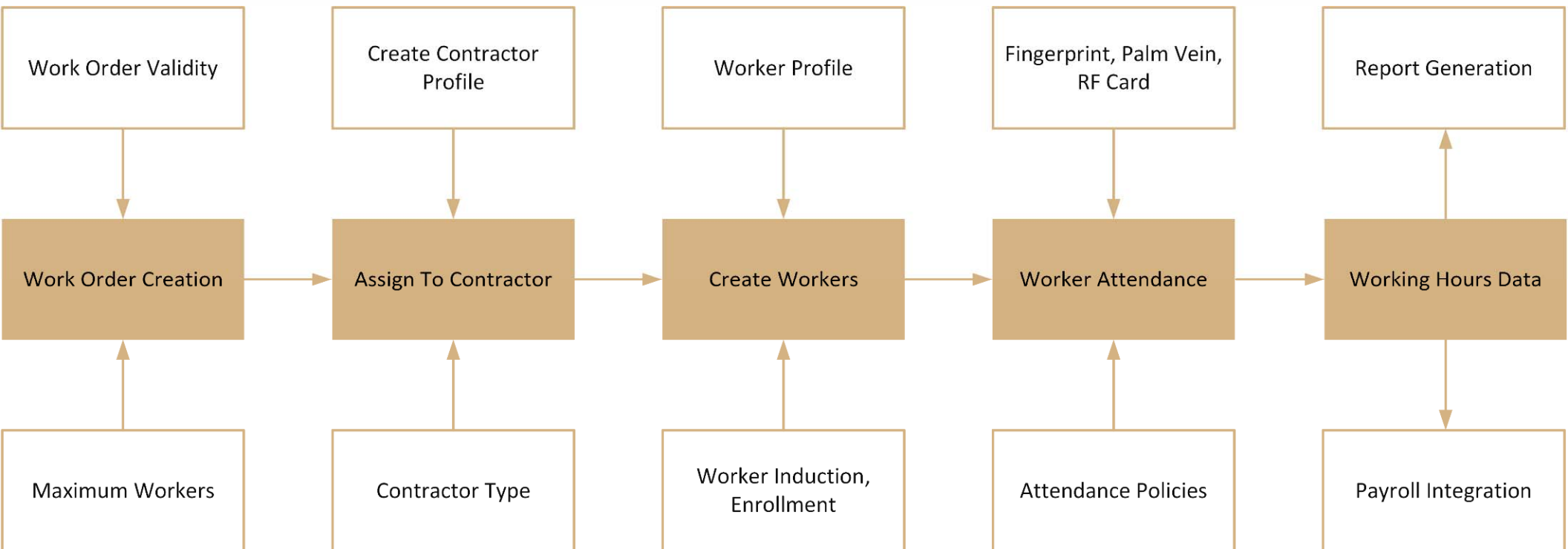

CWM Solution



Features	Advantages	Benefits
Creating work orders and assign them to contractors	Tracking Work Orders	Control Project Progress and Cost
Biometric and RF card based devices for attendance marking	Automated, Foolproof Attendance Capturing	Increase in Productivity and Minimize Overpayment
Flexible Time-Attendance Policies, Shifts, Overtime Policies	Meets Disparate Needs of Different Functions, Locations and Individuals	Faster time-attendance management helps in improve the productivity
Web based Contractor Portal	Update work order status, create new worker profile, report generation by contractors	Save time, Better Planning of Workers

CWM Solution



Features	Advantages	Benefits
Access control for workers	Prevents workers from entering unassigned areas and routes	Enhance security of the organization
Reports and charts	Export reports to various file formats like PDF, Excel, Word, RTF, CSV and TXT	Easy interpretation and decision making
E-mail and SMS notifications	Notifications on worker assignment, worker approval, worker entry/exit, missing in/out punch	Faster response to exceptional situations
Integration with 3 rd party applications	Database-database transfer, API and customized export templates integration methods	Seamless organization for better speed and control which prevents data-entry errors and saves time

Roster Management

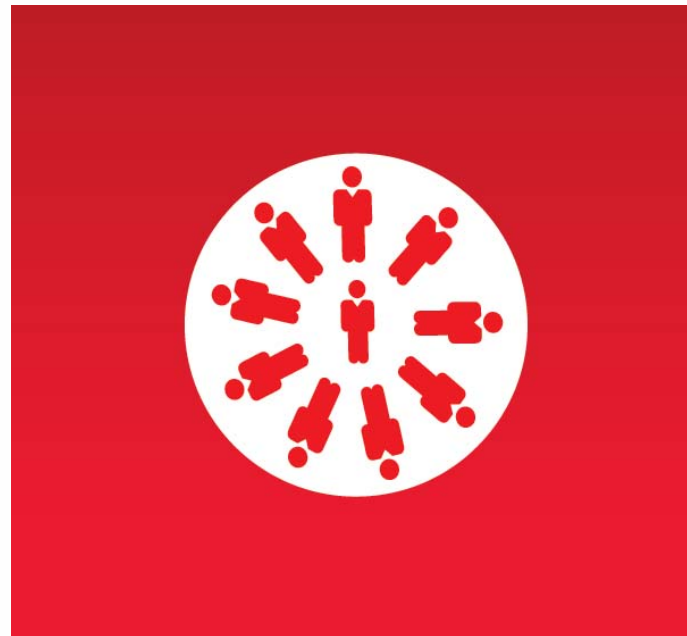

Roster Management Process

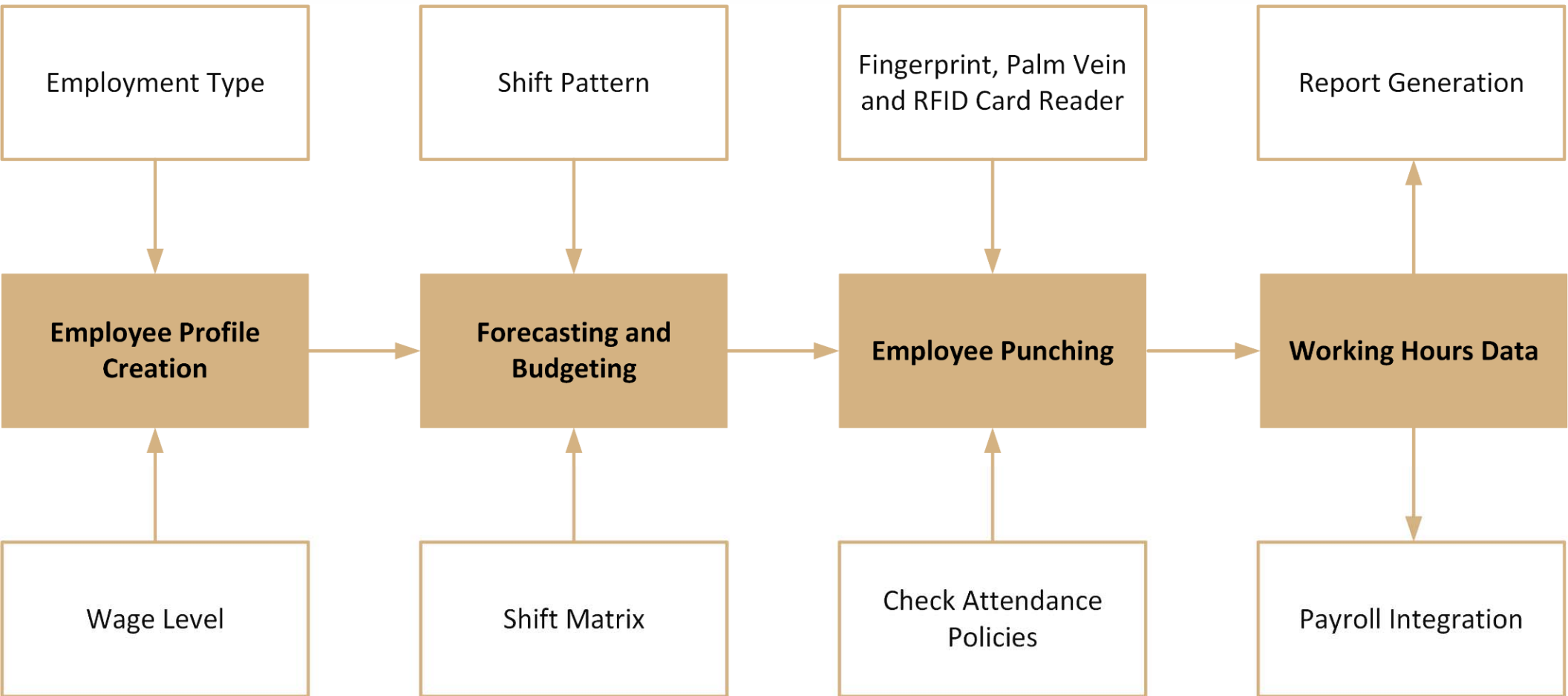

Roster Management Solution



Features	Advantages	Benefits
Employee profile creation	Manager can pull out this detail and get a report anytime from anywhere	Eliminate multiple spreadsheets and related confusions and chaos
Define attendance policies	Accurate attendance data at central place	Increase in productivity, discipline and morale
Auto roster creation	Generates a roster based on the schedule and forecast configured	Proper visibility of workload, availability and options
ESS access to users	Employees and managers both can view and update the details like attendance, shift, leave	Better planning and control
Notifications via SMS and E-mail	Notifications to employees on various events and reminders for shifts	Helps in reducing communication gaps

Roster Management Solution



Features	Advantages	Benefits
Shift pattern and shift matrix	Multiple shift and shift patterns	Saves manager's time from routine work
Multi-week forecasting and budgeting	Helps managers in forecasting employee requirements and the cost	Better planning of project and cost control
Workforce analysis reports	Exclusive range of reports by applying various filters	Easy interpretation and decision making
Integration with 3 rd party applications	Save a lot of time and prevent errors by eliminating manual data entry	Seamless organization for better speed and control
Shift pattern and shift matrix	Multiple shift and shift patterns	Saves manager's time from routine work

Customer Case Study

Matrix COSEC @ Adani Enterprises Ltd

Applications:

- Time-Attendance
- Access Control
- Workers Management Solution
- Visitor Management Solution

Technology:

- Biometric Fingerprint
- Smart Card
- Wireless Connectivity

Solutions Offered:

- Real-Time Monitoring and Control
- Integration with SAP
- SMS and Email Notification
- Integration with Boom-Barrier
- Integration with Card Printing Software
- Centralized Data Management
- Route based Access Control
- Smart Identification
- Network Interface Failover

Matrix Offering:

- Devices: 1200+
- Users: 30,000+
- Locations: India and Indonesia

Benefits:

- Fool-Proof Security in Sensitive Areas
- Proactive Access Control
- Error Free Attendance Data

Matrix COSEC @ Sri Ram Finance



Applications:

- Time-Attendance
- Employee Self Service Portal

Technology:

- Biometric Fingerprint based Devices

Solutions Offered:

- Centralized Attendance Data
- Real-Time Attendance Management
- Integration with Payroll Software
- Door Offline Notification
- Attendance for Field Staff

Matrix Offering:

- Devices: 700+
- Users: 18,000+
- Location: Across India

Benefits:

- Error Free Attendance Data
- Timely Salary Payment
- Centralized Attendance Management

Matrix COSEC @ Aujan Industries Co



Applications:

- Time-Attendance
- Access Control
- Employee Self Service Portal

Technology:

- Biometric Palm Vein Controller
- RFID Smart Card
- Wireless Connectivity

Solutions Offered:

- Accurate Overtime Report
- Centralized Attendance Management
- Integration with Turnstile in Factory
- Accurate Attendance Data for Salary
- Automatic Report Scheduler
- Employee-wise Portal for Attendance
- Fast and Accurate Palm Identification

Matrix Offering:

- Devices: 20+
- Users: 500+
- Locations: KSA (HO and Factory) and Dubai

Benefits:

- Restrict unauthorized Access in Manufacturing Unit
- Error Free Attendance Data for Salary Processing
- Accurate Overtime Payment



About Matrix

About Matrix



- Established in 1994
- 250+ Security and Telecom Products
- 500+ Channel Partners
- 350,000+ Satisfied Customers
- 50+ Countries Reach
- 700+ Man-years of R&D Experience
- ISO 9001-2008 Certified
- Global Quality Certifications





CORPORATE OFFICE

- Based at Vadodara, Gujarat, India
- Departments: Marketing, Sales, Product Management, Support, Finance, Customer Care, Purchase

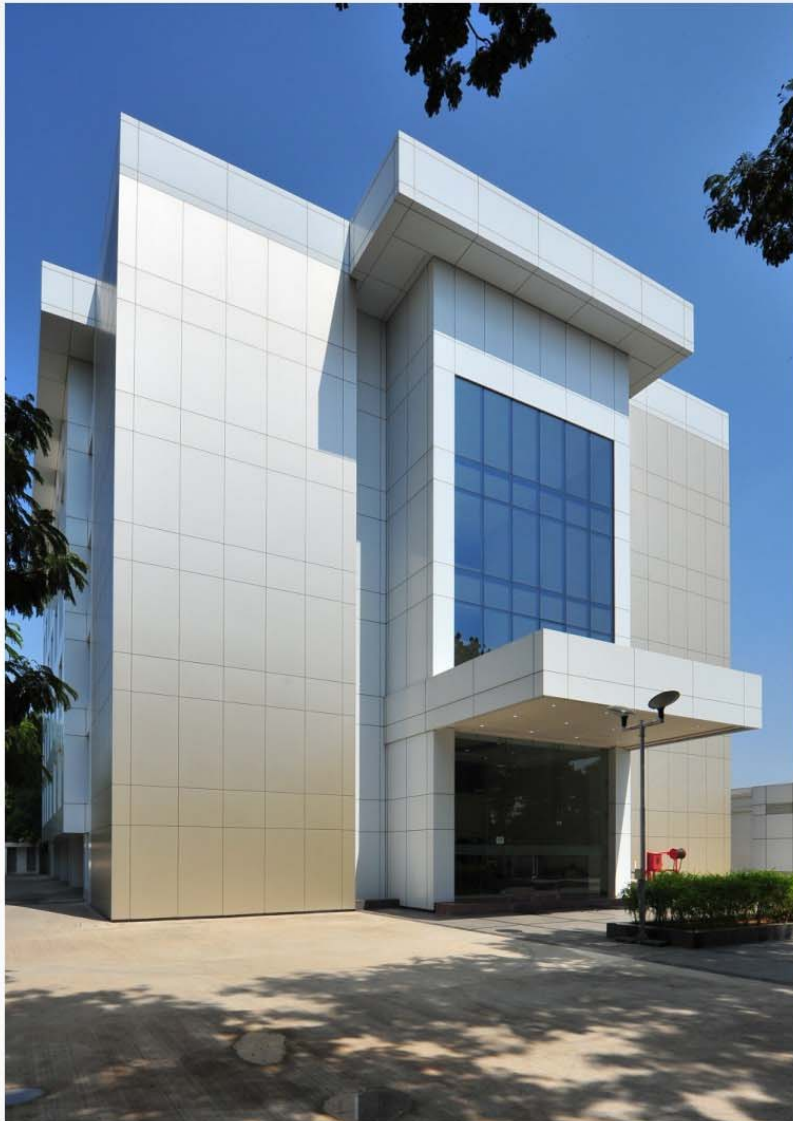

R&D CENTER

- 77,000 Sq.Ft
- More than 40% Manpower in R&D, 700+ Man-years of R&D Experience
- World-class Technology Platform and Processes

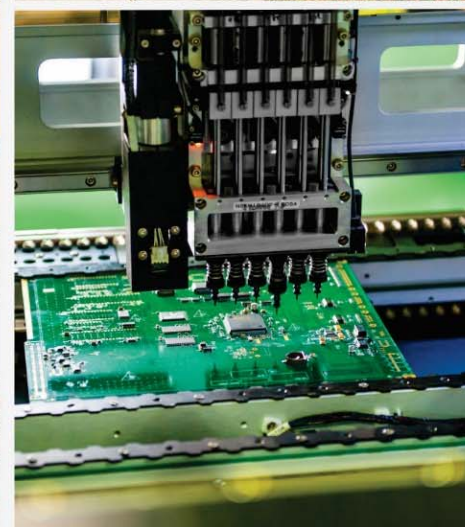

MANUFACTURING UNIT

- 73,000 Sq.Ft
- 100+ Work Stations
- International Quality Systems and Processes

Awards and Achievements



- 2012 **India Design Mark Award** for Matrix Time-Attendance and Access Control Solutions



reddot design award

- 2010 Internationally Acclaimed **RED DOT Design Award** for Matrix Security Solutions



product design award

- 2010 Germany based Internationally Acclaimed **IF Design Award** for Thoroughly Engineered and Innovative Matrix Security Solutions



- 2007 **IETE Corporate Award** for Excellence in Computer and Telecommunication Systems by the Institution of Electronics and Telecommunication Engineers, India

Awards and Achievements



सत्यमेव जयते

GOVERNMENT OF INDIA
Ministry of Communications
& Information Technology

- 2004 the **Award for Excellence in Professional Electronics**, conferred by the Ministry of Communication and Information Technology, Government of India

Others Awards and Achievements

- 2009 the **Best Managed Company** by Baroda Management Association, India
- 2008 the **Best SSI Unit Award** by the Federation of Gujarat Industries (FGI), India
- 2008 the **Best Electronics Company Award** by the Gujarat Electronics and Software Industries Association (GESIA)
- 2004, 2005, 2006, 2007, 2010, 2011
the **EFY Readers' Choice Award for the Best PBX-KTS Company**
Conferred by popular EFY Magazine

For Further information,
Please Contact



Email	More@MatrixComSec.com
Contact No	+91 265 2630555
Website	www.MatrixSecuSol.com
Address	394-GIDC Makarpura, Vadodara-390010, Gujarat, India

We put
more
in the box

so your
business
can think
more
out of
the box.



Thank You.